

diener
Plasma-Surface-Technology

PLASMA TECHNOLOGY

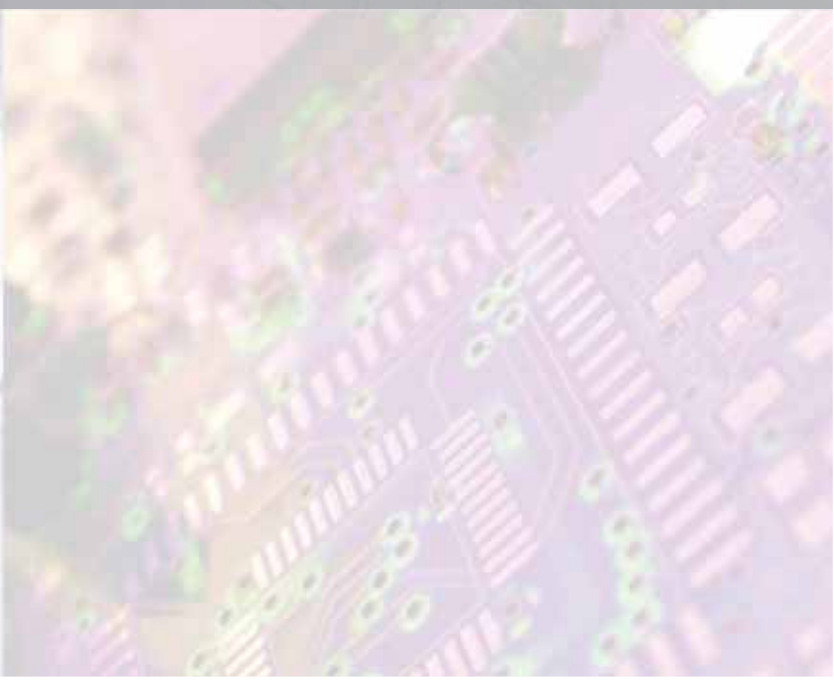

Plasma technology
First published, 2007

Published by:

Diener electronic GmbH + Co. KG
Talstr. 5
72202 Nagold
Germany

<http://www.plasma.de>

© Diener electronic GmbH + Co. KG

All rights reserved. This publication may be reproduced
or transmitted only with permission in writing from the
publisher.

Suggestions and remarks on this publication should be
sent, if possible, by Email to:

info@plasma.de

Technical modifications are subject to change

Publishing date: 06.09.2007

Content

1. Introduction into low-pressure plasma technology	7
1.1. How does a low-pressure plasma system work?	7
1.2. What is plasma?	10
2. Low-pressure plasma technology	13
2.1. Applications.....	13
2.1.1. Cleaning	13
2.1.2. Activation.....	15
2.1.3. Etching	21
2.1.4. Coating by plasma polymerization.....	22
2.1.5. Special Processes.....	24
2.2. Plasma Systems	37
2.2.1. Standard systems - Overview	37
2.3. Controls.....	47
2.3.1. Process sequence.....	47
2.3.2. Semi-automatic (manual) control	47
2.3.3. Fully automatic control.....	48
2.3.4. PC-Control	49
2.4. Which frequency is the best frequency?	52
2.5. Running costs of a plasma system	54
2.6. Vacuum Pumps	56
2.6.1. Rotary Vane Pump	56
2.6.2. Dry running vacuum pumps.....	56
2.6.3. Roots Pump	59
2.7. Supplied options	62
2.7.1. Rotary drum	62
2.7.2. Spare part kit.....	63
2.7.3. Additional gas channels	63
2.7.4. Polymerization Accessories	64
2.7.5. Measurement of bias voltage.....	64
2.7.6. Automatic Door	65

2.7.7. Special flange / Additional flange.....	65
2.7.8. Safety valve	66
2.7.9. Network connection	66
2.7.10. Maintenance service	66
2.7.11. Hot plates	66
2.7.12. Pressure Reducers	66
2.7.13. Customised carriers / electrodes	67
2.7.14. RIE electrode.....	70
2.7.15. Ion flow measuring sensor	71
2.7.16. Test inks	71
2.7.17. Butterfly valve.....	72
2.7.18. Active carbon filter	72
2.7.19. Label Printer	73
2.7.20. Suction filter for vacuum	73
2.7.21. Barcode Reader	74
2.7.22. Temperature measurement with thermocouples.....	74
2.7.23. Quartz glass chamber	74
2.7.24. Quartz glass boat	75
2.7.25. Generators of LF, RF, MW	75
2.7.26. Accessories for operation of special gases	75
3. Process technology at atmospheric pressure in plasma	76
3.1. Applications.....	76
3.2. Principle of construction and function	78
3.3. Partial description of an atmospheric plasma system	81
3.3.1. Front view.....	81
3.3.2. Rear view.....	82
3.4. Process Gas.....	83
3.5. Emissions	83
3.6. Technical Data of a standard system	83

1. Introduction into low-pressure plasma technology

1.1. How does a low-pressure plasma system work?

The most important components of a system are the **vacuum chamber**, the **vacuum pump** and a high-frequency generator for plasma creation.

The principle process of a low-pressure system can be most simply explained by figure 1 and 2.

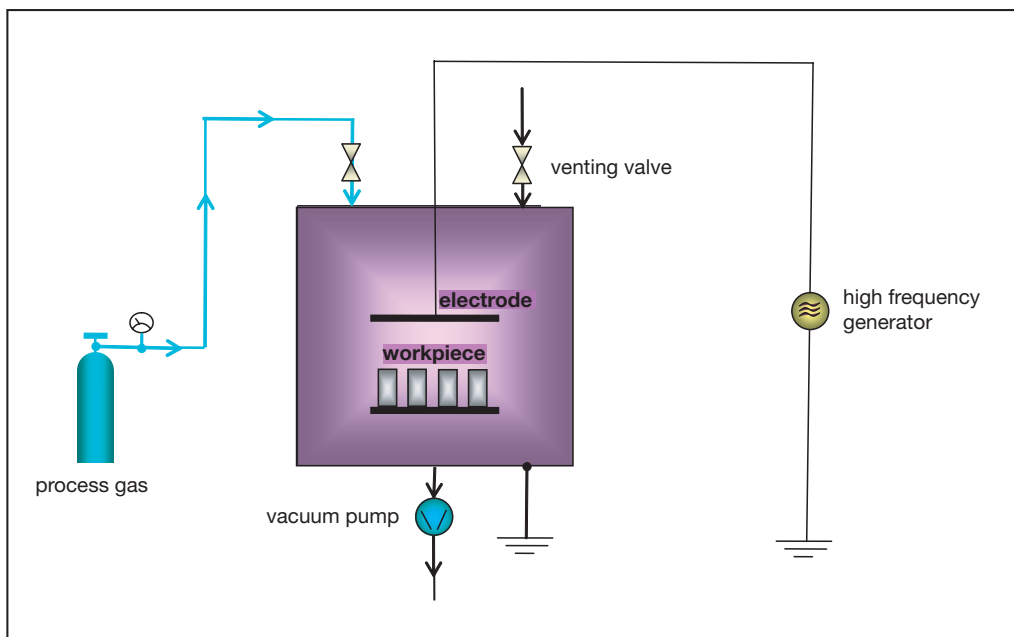

fig. 1: schematic of kHz and MHz plasma systems

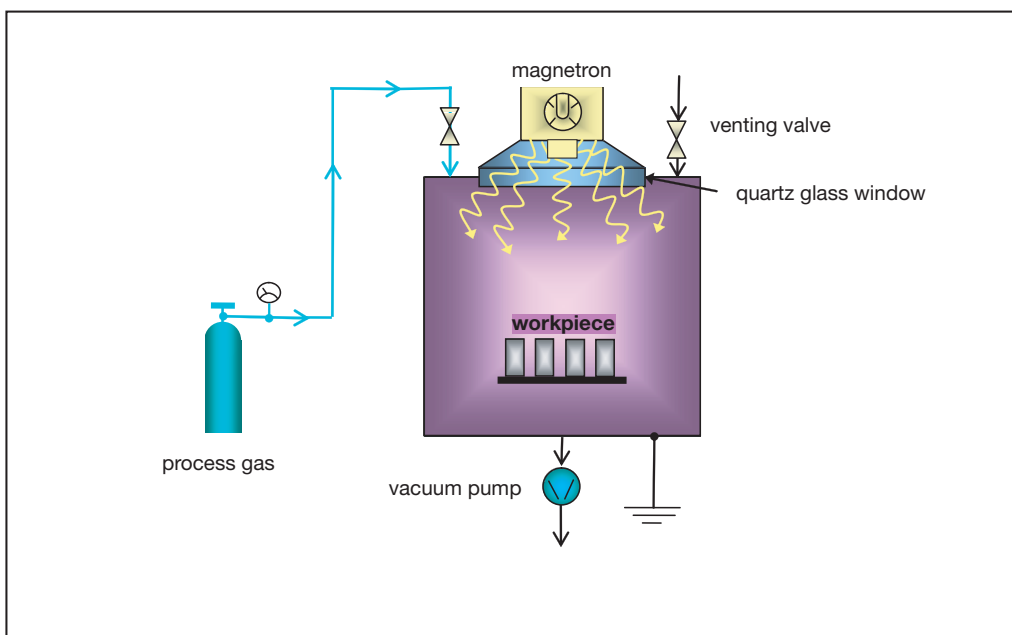

fig. 2: schematic of a microwave plasma system (2,45 GHz) with metal chamber

- The Steps of a plasma process are shown in figure 3 as follows:

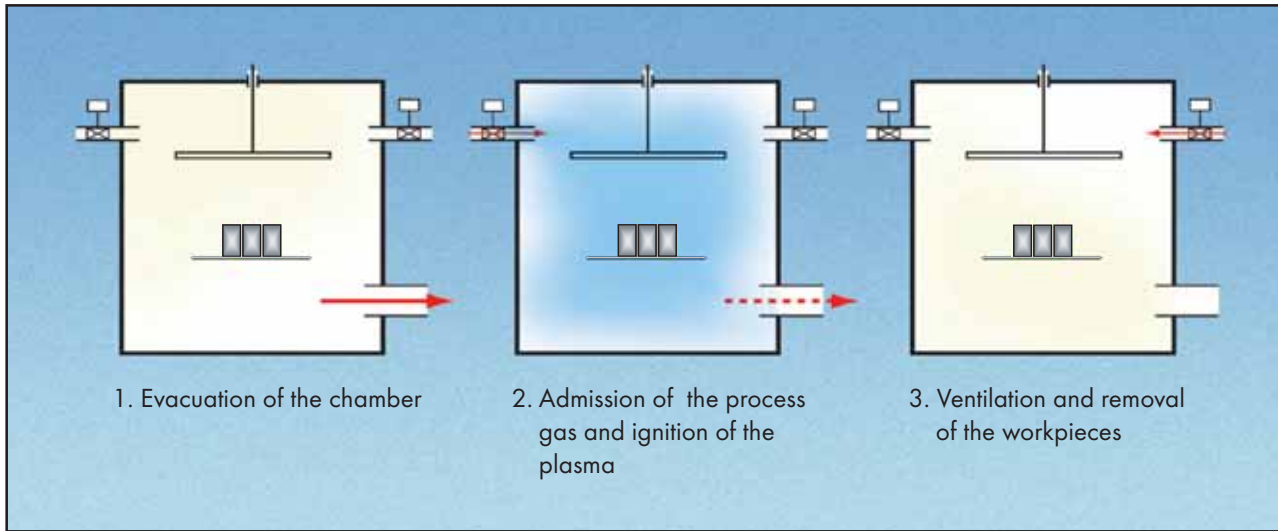

fig. 3: process sequence of plasma treatment

At first **low pressure is created** in a recipient by means of a vacuum pump. At a pressure of approx. 0.1 mbar the **process gas** (i.e. oxygen) is fed **into the chamber**.

The working pressure field is ca 0.1 to 1.0 mbar. When **working pressure is achieved**, the **generator is switched on** and process gas in the recipient is getting ionized. The component for treatment is exposed to the plasma. The plasma system receives continuously fresh gas whilst contaminated gas is sucked off.

The configuration of a plasma system can differ widely since it can be applied to various options.

One option of varying parameters is the **volume** of the recipient. The chamber size is configured according to size and quantity of the component to be treated. Large recipients can have a volume of 10,000 ltrs and more. Laboratory systems have a volume in the range of 1 to 50 ltrs.

Vacuum pumps are adjusted to recipient size and the desired gas throughput during the plasma process.



fig. 4: laboratory system „Femto“



fig. 5: special system „TETRA-12600“

Further options of parameter variations concern **the method of plasma creation**. Energy, necessary for plasma creation, can be coupled to the chamber in different ways.

In **kHz-** (40kHz) and **MHz** machines (13.56MHz) one electrode is likely to be placed within the plasma chamber (see figure 1).

In **microwave machines (2.45GHz)** one aerial is permanently built into the magnetron. The magnetron is an electron-tube-oscillator that oscillates at a fixed frequency. The aerial of the magnetron must not be based within the vacuum. For that reason microwaves are directed onto a glass or ceramic window to enter the chamber (see figure 2).

Moreover, there are many **additional options** (see chapter 2.7. "Supplied Options")

For **process development** it is vital to treat specimens. You should therefore not delay in sending us your sample parts.

Standard applications are carried out **without charge**. Should, however, the process for specimens exceed the usual frame of work we will be able to make a quote for the particular process to be developed. This applies in particular to the process of plasma polymerization. Often it is also necessary to carry out trials on site as storing time differs according to longterm stability of activation and kind of material which could be between a few minutes and several weeks (see chapter 2.1. "Application in low-pressure plasma" and 2.1.2. "Activation"). Renting plasma systems is best suited for this purpose.

Examples of sample parts/product groups:



fig. 6: automotive industry



fig. 7: medical technology



fig. 8: semiconductor / electronics



fig. 9: gasket / elastomer



fig. 10: all kinds of plastic



fig. 11: e.g. aki goggles



fig. 12: sensors / detectors



fig. 13: metals



fig. 14: powder

1.2. What is plasma?

If you continuously apply energy to matter, its temperature is rising and undergoes the process from solid-state to liquid and gas. Carrying on applying energy the existing shell of the atom is breaking up and electrically charged and excited particles and molecule fragments are formed (negatively charged electrons and positively charged ions, radicals). This mixture is called plasma or the fourth state of matter (aggregate state).

In short: changes of the aggregate state under applied energy:
Solid → liquid → gas → plasma

In nature plasma is found in lightning, the Northern Lights, flames and in the sun. Artificially created plasma is known among other things in neon tubes, welding and flashlights.

Schematic of a plasma chamber:

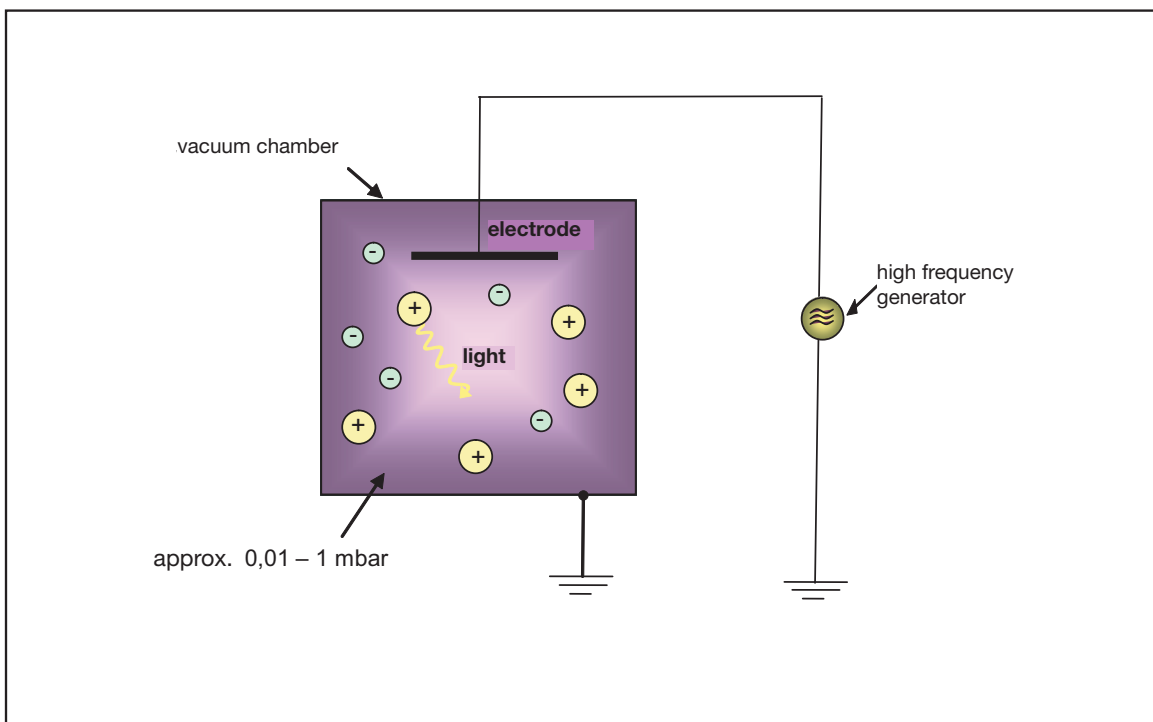

fig. 15: schematics of a plasma chamber

Ionisation starts by the collision of an electron (negatively charged particle) with a molecule of the residual gas. A further electron is shot from the molecule. The molecule becomes a positively charged ion and moves towards the cathode. The electron moves towards the anode and meets further molecules. The accelerated cations release numerous electrons from the cathode. This process continuous like an avalanche until the gas is completely ionised. Various collisions lead to light visible emission. This electrical gas discharge remains as long as there is an energy source.

Alternating voltage sources are applied at different frequencies. The benefits and shortcomings of different excitation frequencies are described in chapter 2.4 “Which frequency is the best frequency”.

Plasma in the low-pressure range heats up components for treatment only slightly. During activation of plastics, i.e. polypropylene, heating is barely measurable. During degreasing, it is possible that treated components heat up to 150°C. If parts are temperature sensitive, cooling or lowering power can regulate temperature.

The most famous application of plasma is the **neon tube**. There is visible and invisible **radiation** in plasma processes. The range of produced radiation extends from infrared to ultraviolet. Infrared radiation has relatively little significance in the plasma process; it merely causes heating of the component for treatment. **Visible radiation** serves primarily **process observation**. Through colour and intensity parameters like pressure, gas type and generator power can be controlled. **UV radiation** has a strong **impact on the process** as it causes chemical and physical reactions in components for treatment.



fig. 16: helium plasma



fig. 17: oxygen plasma, high pressure



fig. 18 : oxygen plasma, low pressure

In plasma processes different effects are made use of.

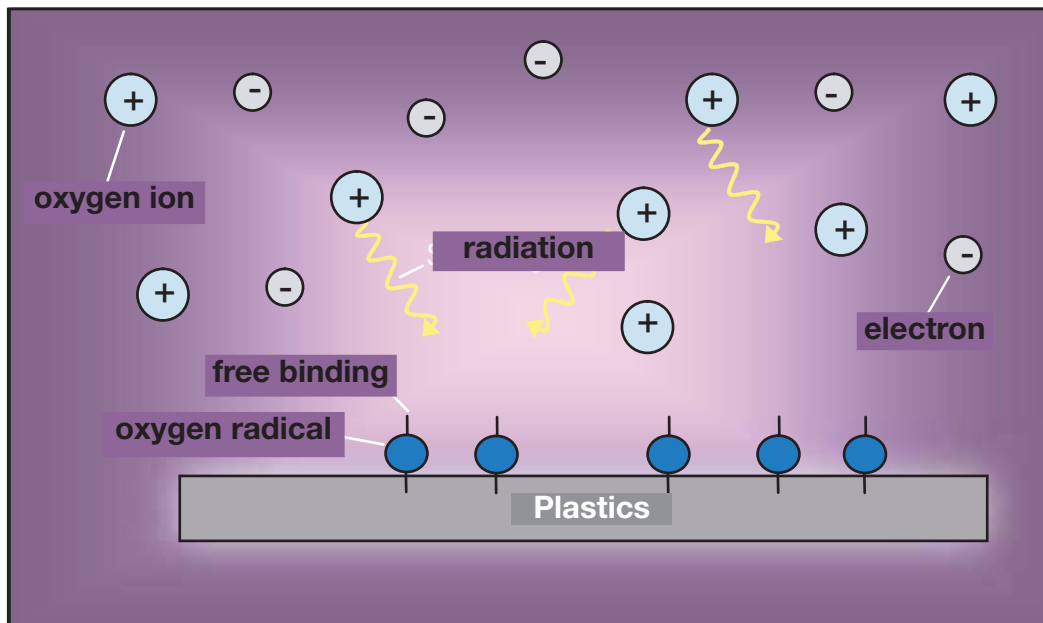

fig. 19: effects on plasma process

To some extent the surface of parts to be treated is only **mechanically** “micro-sandblasted” by energy-rich gases (i.e. inert gas plasma). The emerging plasma reacts chemically with the treated part (i.e. oxygen plasma). The IR/UV-radiation content of plasma is breaking down carbon chains, with oxygen providing a greater surface for reaction and radical points are created. (fig. 19).

In **polymerization processes monomers** are introduced into the chamber, which react chemically among each other to polymers and then settle down as a **layer** onto the treated part.

2. Low-pressure plasma technology

2.1. Applications

2.1.1. Cleaning

2.1.1.1. Cleaning of metals

Some components are covered with **grease, oils, wax** and other **organic** or **inorganic** contaminants (also oxide layers).

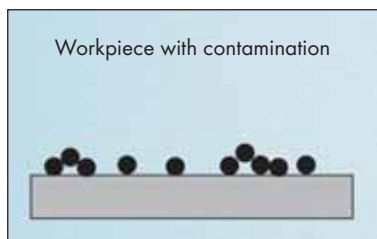

fig. 20: Before plasma treatment

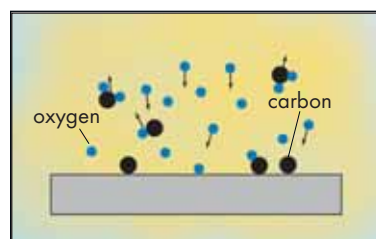

fig. 21: plasma treatment

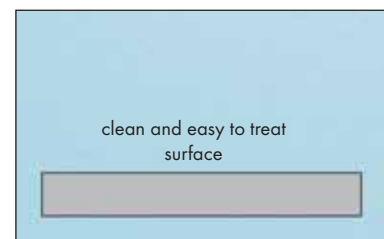

fig. 22: After plasma treatment

For certain applications it is essential that completely clean and oxide-free surfaces are achieved. For example:

- Before **sputtering processes**
- Before **lacquering processes**
- Before **gluing**
- Before **printing**
- In **PVD and CVD Coating**
- In **special medical applications**
- With **analytical sensors**
- Before **bonding**
- Before **soldering of conductor plates**
- With **switches** etc

In these cases plasma reacts in two different forms:

A. It removes organic layers:

- These are chemically attacked by **oxygen** or **air** (fig. 20-22)
- By low-pressure and heating on the surface contaminants partially **evaporate**
- By energy-rich particles in plasma contaminants are **broken down** into smaller molecules and therefore can be sucked off
- Also **UV radiation** can destroy contamination

Contamination should only be a **few micrometres** thick, since plasma is only capable of cleaning away a few nm/s.

For example grease contains lithium compounds. Only **organic constituents** can be removed from those. The same applies to **fingerprints**.

B. Reduction of Oxides:

- Metal oxide **chemically** reacts with the process gas (fig. 23-25). Pure hydrogen or a mixture of argon and nitrogen is used as a process gas.

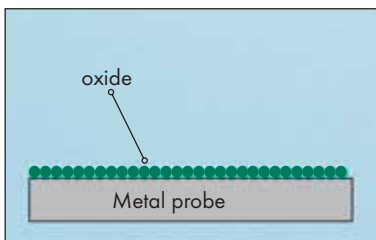

fig. 23: Before plasma treatment

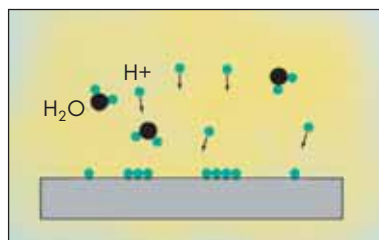

fig. 24: plasma treatment

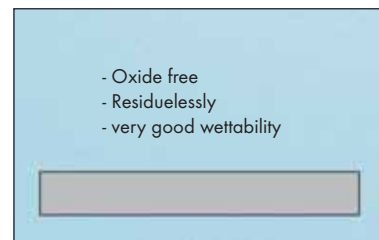

fig. 25: After plasma treatment

It is also possible to execute processes in **two stages**. For example treated parts are first oxidised with oxygen for 5 min (fig. 20-22) then they get reduced by argon-hydrogen (e.g. mixture of 90% argon and 10% hydrogen) (fig. 23-25).

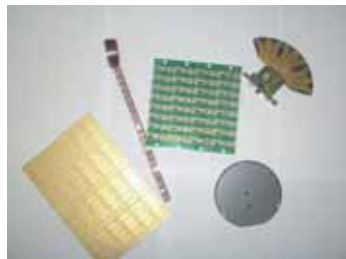

fig. 26, 27, 28 : Examples for cleaning application of metals

2.1.1.2. Cleaning of plastics

Cleaning of plastics is always part of the activation of plastics. Should one plastic indeed only be cleaned and not be activated, process parameters have to be reduced until the desired effect is achieved, whereupon it should be considered, whether the mere cleaning process of the part is sufficient for those succeeding. (See chapter 2.1.2.2 "Activation of plastics").

Technical **oxygen** is usually used as process gas, yet often ambient air is sufficient. Plasma treatment can be repeated and **no toxic gases are created**.

The principle is according to the cleaning of metals (see Fig 20-22)

2.1.1.3. Cleaning of glass and ceramic

Cleaning of glass and ceramic is carried out in the same manner as cleaning of metals (see chapter 2.1.1.1 “Cleaning of metals”). The recommended process gas for cleaning of glass is e.g. argon and oxygen.

In general it can be said that cleaning is mostly carried out with oxygen plasma. Other parameters like pressure, power, gas flow, and duration of treatment depend on the sensitivity of the parts to be treated.

2.1.2. Activation

2.1.2.1. Activation of metals

Activation of metal is in principle possible; however, activation of metal is very unstable and therefore lasts only for a short period. If metal is activated, it has to be reprocessed within less than minutes or hours (clued, lacquered...) as deposited radicals and ions combine quickly with particles of ambient air.

However, a plasma system can be rented or bought at any time to undertake this application **on site**.

It is sensible to have metal activation prior to processes such as soldering and bonding.

Soldering:

Following processes are possible for pre-treatment of soldering:

- a) Soldering under vacuum: For special applications soldering under vacuum is possible. In this case no flux is required.
- b) Long-term stored electrical components, which have oxidised over time. Oxidation can be eliminated by hydrogen plasma.

Bonding:

Often **organic contaminants**, in example, residua of electroplating processes, of adhesives, of flux residuals etc. disturb bonding. These can be removed by plasma. Equally **oxide layers** can worsen the bonding process. These can be reduced by hydrogen plasma.

2.1.2.2. Activation of plastics

Plastics, i.e. polypropylene or PTFE (Polytetrafluoroethylene) are themselves of **homopolar** structure. This means that plastics have to be pre-treated **before printing lacquering and gluing**. Gas and ceramics are to be treated similarly. Technical **oxygen** is usually used as process gas. However, many activations can also be carried out with ambient air.

Parts remain active for **a few minutes up to some months**. Polypropylene can still be reprocessed several weeks after treatment. Nevertheless, we recommend not storing parts openly as they attract dust and air humidity.

Advantages:

- Unlike flaming, plasma treatment can be repeated.
- Compared to flaming and corona treatment, **consistency** is significantly higher. There are no toxic gases.
- The choice of process gases is much greater. Also **gaps** and **hollow** parts can be treated from inside.
- **Primers** are no longer required, the same applies to PTFE.
- Plasma treatment applies to **all plastics**.
- The method is very **environmentally friendly**.
- Consumption of **gas** is minimal (ca 10 cm³/min - 1,000 cm³/min).
- Low-pressure plasma systems are very inexpensive compared to many competitive processes - see chapter 2.4 "Which frequency is the best frequency?" and chapter 2.5 "Running costs of a plasma device"

Examples of a variety of applications of plasma activation and plastic surface areas:



fig. 29: contact lens



fig. 30: catheter



fig. 31: telephone receiver



fig. 32: prosthesis



fig. 33: automotive components



fig. 34: ski goggles



fig. 35: bicycle saddle

Activation can be demonstrated impressively by immersing a treated and untreated part into water. As usual water droplets are formed on the untreated part. The treated part is completely wetted by water.

Strength of activation can be tested quickly and simply by two methods:

Contact Angle Measurement:

This process measures the **contact angle** (fig. 36) of a water droplet with regard to surface area of activation. The better the activation, the more flattened is the water droplet on the surface. However, this process is rarely applied since measuring equipment is relatively expensive and generally cannot be measured immediately on site.

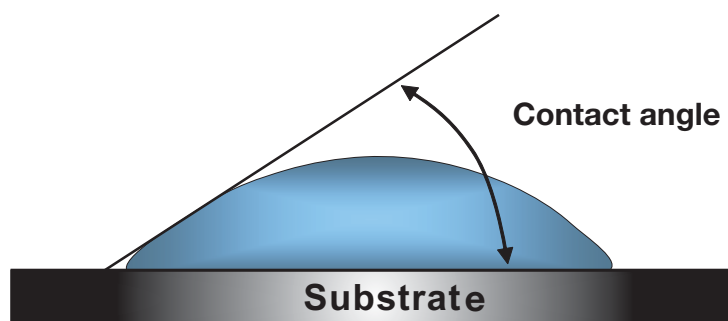

fig. 36: contact angle

Example of photos (taken under the microscope)

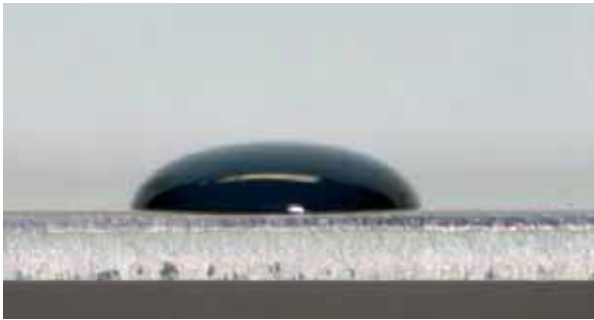

fig. 37: untreated surface

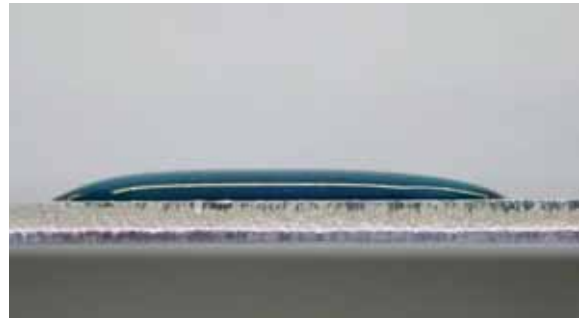

fig. 38: activated surface



fig. 39: untreated surface

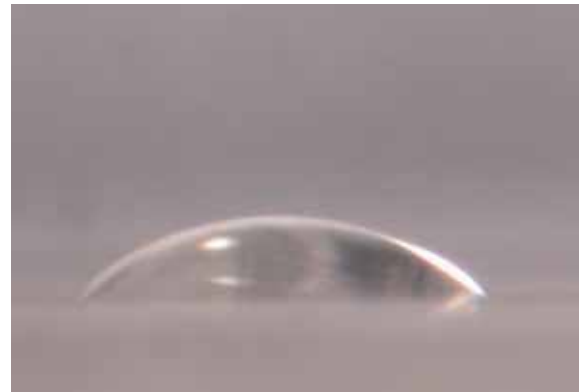

fig. 40: activated surface

The other process uses different **test inks**. Depending on the course of these test inks, a designated **surface energy** can be assigned to these treated parts. The unit is mN/m [formerly: dyn/cm].

Water possesses a surface energy of 72.6 mN/m. Test inks are available in 10 steps from 28 mN/m - 105 mN/m.

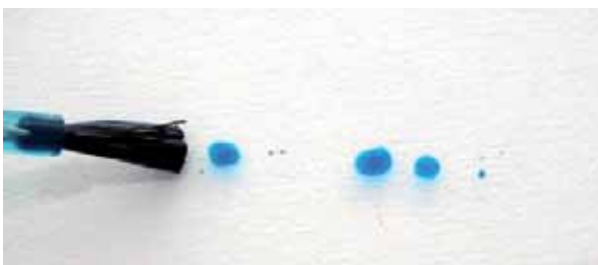

fig. 41: untreated surface (< 28 mN/m)



fig. 42: treated surface (72 mN/m)

Generally it can be assumed that water wettability indicates sufficient pre-treatment for a lacquer. A surface energy of 72 mN/m is necessary to reach sufficient adhesion. However, this might not apply to all cases.

Activated surface areas are **mechanically sensitive**. Rubbing them with a cloth takes off the activated layer. Treated parts may only be touched with gloves.

If process times are longer (>ca 15min) surface areas are not only activated but also etched. In this way the area becomes matt. Etched areas reach optimal bonding. Lacquers are normally tested by the so-called **grid-cut test** (cross-cut test) (Norm: DIN EN ISO 2409 and ASTM D3369-02). It requires varnishing of plastics followed by a right-angled lattice pattern cut with a grid-cut testing device. Afterwards an adhesive tape specified by norm standard is applied and pulled off. If particles of lacquer are found on the adhesive tape, the coating is defect. Various scales of defects are described in standard norms.

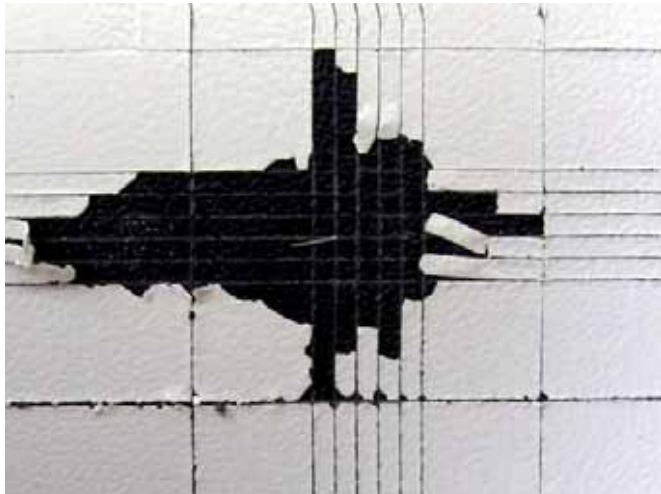

fig. 43: Grid-cut test, untreated

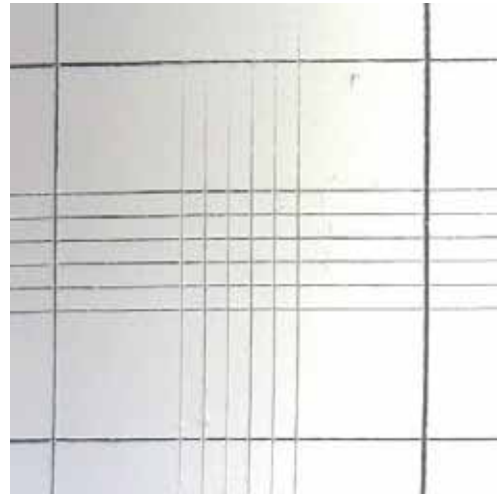

fig. 44: grid-cut test, treated

A plasma reaction during **plastic activation** can be seen in figure 45 - 47. (Similar applies to activation of glass and ceramics)



fig. 45: Before plasma treatment

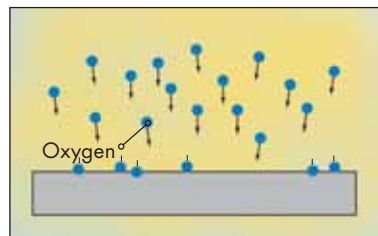

fig. 46: plasma treatment

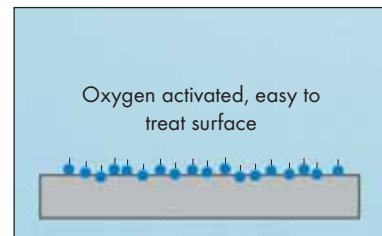

fig. 47: After plasma treatment

- A.** Plasma removes **separating agents** (also silicone and oils) from the surface area.
- For example these are **chemically** attacked by oxygen.
 - Low pressure and heating on the surface area can **evaporate** separating agents partially.
 - Energy-rich particles of plasma **break down** separating agent molecules into smaller molecule fragments and can therefore be sucked up. This creates a **“micro-sandblast effect”**.
 - **UV radiation** can break-up separating agents.

- B.** Plasma reacts with the **plastic surface area** (fig. 45-47)
- Process gas **reacts** with the plastic surface area and is depositing there. When using oxygen, **radical positions** with good affinity to polar compounds are created in the surface area.
 - Process gas is **sandblasting** the area and hence creates radical points, i.e. activation of POM and argon.
 - **Softeners** and other undesired **fillers** are broken down or evaporated.
 - **UV radiation** creates radicals

Process gasses, which could be considered: e.g. **air, oxygen, argon, argon-hydrogen and tetrafluoromethane-oxygen.**

Storing time (until reprocessing) is depending on different factors, i.e. mixture of resins and means of packaging. After plasma treatment welded parts have considerable higher storage life than left openly. The lifetime of polyamide could be several years.

2.1.2.3. Activation of glass and ceramics

Glass and ceramics behave similarly to metals (see chapter 2.1.2.1., “Activation of metals”) and due to the structure of their surface area are not easily activated but can be etched (see chapter 2.1.3.3., “Etching of glass and ceramics”).

2.1.3. Etching

In plasma etching gases are used which can create a phase change of the etched material (e.g. etching of silicon containing fluorine gas, fig. 48-50). The gas enriched by base material is sucked up and fresh gas introduced. In this way continuous extraction is achieved. Applying a resistant etching mask (e.g. chromium) to the process gas used, areas can be protected. Hereby a surface area can be systematically structured. These structures are of nanometre magnitude.

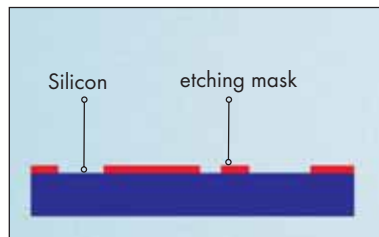

fig. 48: silicon with etching mask before plasma treatment

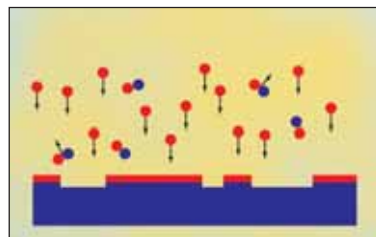

fig. 49: plasma treatment

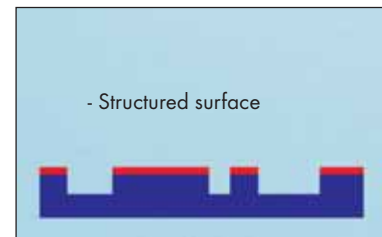

fig. 50: after plasma treatment

2.1.3.1. Etching of metals

In principle etching of metals is possible. And yet it does only work with some metals.

Example of application: Etching of aluminium using chlorine

2.1.3.2. Etching of plastics

These processes etch especially plastic surface areas. Etching is very important with plastics, which are difficult to lacquer and to glue, like POM or PTFE. The enlarged surface area reaches better bonding. Typical etching gases are oxygen, different fluorine/chlorine gas compounds but also hydrogen.

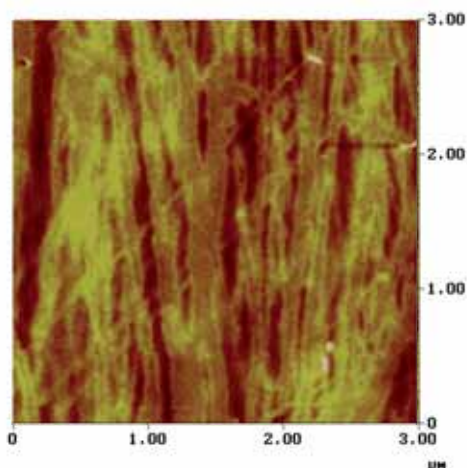

fig. 51: AFM picture of a untreated PC surface

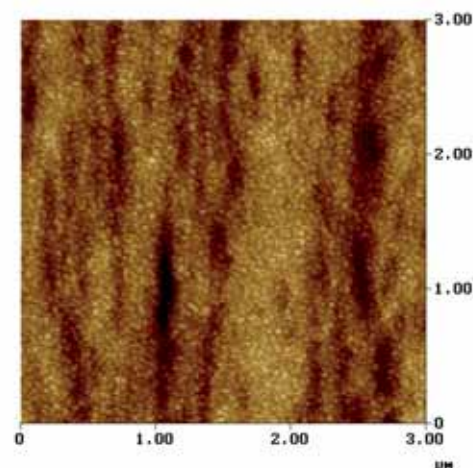

fig. 52: AFM picture of an O₂-plasma treated PC surface

Pictures with kindly permission of Dr. Ing. Andreas Hegenbarth, IKV Aachen

Examples of changing microstructure on the surface area by plasma etching: An oxygen plasma excited by microwaves executes the etching attack. The substrate material is polycarbonate. The picture on the right shows a fine, globular arrangement, which is created by interchange reaction of plastic surface area and plasma.

2.1.3.3. Etching of glass and ceramic

Plasma etching of **glass** in vacuum is time-consuming and expensive. Glass is only slowly broken down by ionised gas particles. Glass consists greatly of SiO₂ and therefore fluorocarbon (by adding oxygen) can principally be used for etching. Low depositing rate and resulting long process time increases cost of these processes.

2.1.4. Coating by plasma polymerization

Low-pressure plasma also enables coating of components (fig. 51-53).

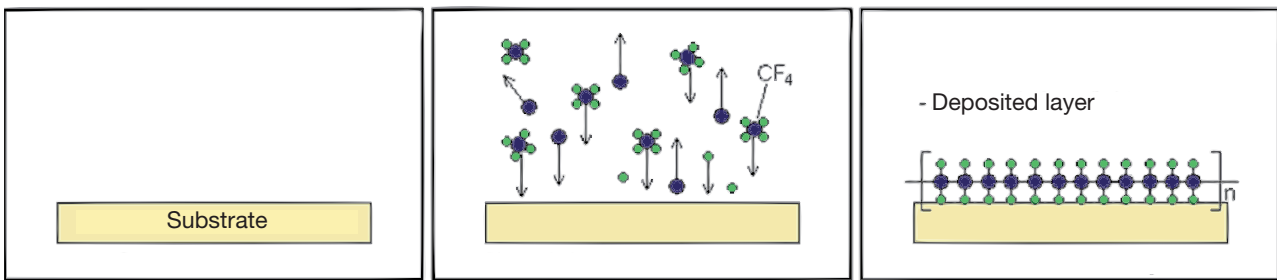

fig. 51: before plasma treatment

fig. 52: plasma treatment

fig. 53: after plasma treatment

Monomers are fed into the recipient, which then polymerise under the influence of plasma. This process technology is considerably more complex than activation and degreasing. Examples of this application are:

- Barrier coats of fuel tanks
- Scratchproof coats on headlights and CDs
- PTFE-like coating
- Hydrophobic coats etc

In plasma polymerization thickness layers reached are in the region of one micrometer. Adhesion of layers on the surface area is very good.

Development of customised layers is generally time-consuming. This must be accounted for.

There are three coating types, which are already established:

1. Hydrophobic Coating: Monomers: i.e. hexamethyldisiloxane
2. PTFE-like Coating: Monomers: Process gases containing fluorine. (See chapter 2.1.5.6. "Epilam Coating")
3. Hydrophilic Coating: Vinylacetate

Images of coating:

Scratchproof coating on polycarbonate

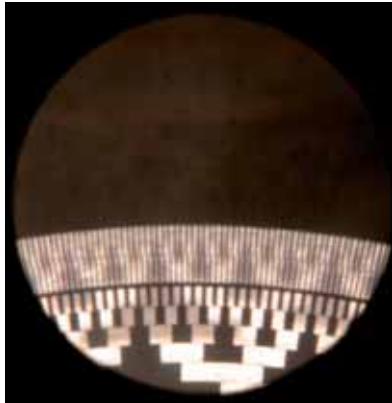

fig. 54: Original condition

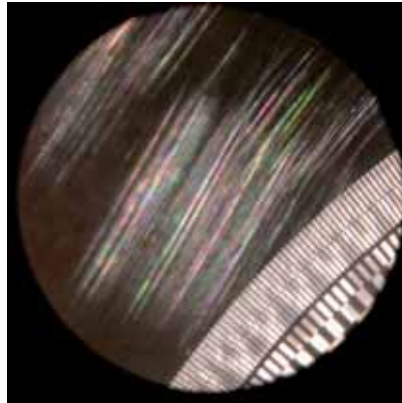

fig. 55: Scratch test (untreated)

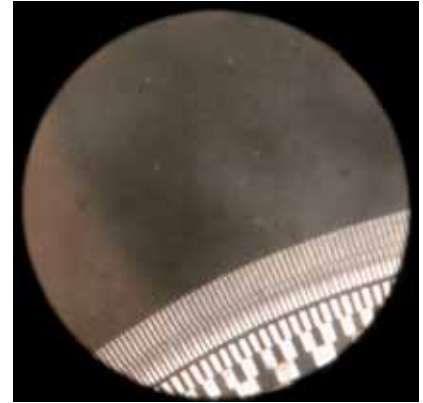

fig. 56: Scratch test (treated)

Hydrophilic Coating on metal

For better visibility water droplet is coloured



fig. 57: Metal surface untreated

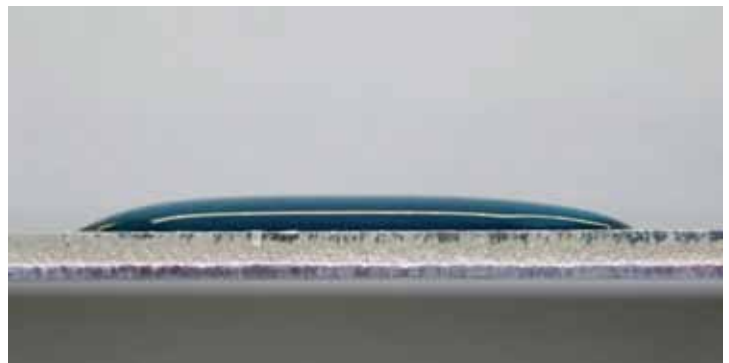

fig. 58: Metal surface treated

Hydrophobic Coating on textile (cotton)

For better visibility water droplet is coloured.

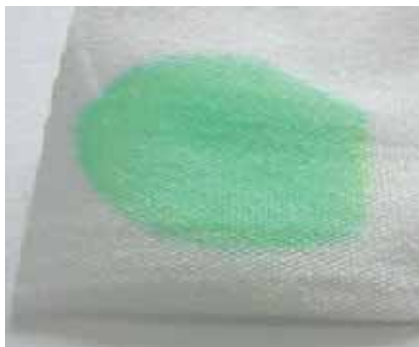

fig. 59: untreated cotton (water)



fig. 60: treated cotton (water)
hydrophobic



fig. 61: treated cotton
(isopropanol)

2.1.4.1. Coating of metals by plasma polymerization

Coating of metals by plasma polymerization enables different effects, i.e. an activation lasting up to several weeks and next to creating decorative also creating functional coats.

2.1.4.2. Coating of plastics by plasma polymerization

Plastics can be coated to a large extent without complications by plasma polymerization. For example, CDs and DVDs can be scratchproof coated without jeopardising their quality. PTFE-like coats can be applied to increase smoothness of treated parts. Further it is possible to target functional groups to be attached to the surface area of the resins (e.g. amino groups for bio analytical applications).

2.1.4.3. Coating of glass and ceramics by plasma polymerization

The one and only difficulty of coating glass and ceramic lies in the appropriate preparation of surface areas (see chapter 2.1.2.3. and 2.1.3.3.). As soon as this hurdle is overcome nothing will obscure the choice of variety in application of coating. Individual bonding strength of the coat will have to be tested in some case. Should there be any “mismatch” between coat and substrate material, it may be necessary to apply intermediate coats to create adhesion. One example of successful hydro- and oleophobic coating is shown in the picture.

Image of droplets (same order with both glasses)



fig. 62: untreated object holder
left: linseed oil / middle: isopropanol / right: distilled water



fig. 63: treated object holder
left: linseed oil / middle: isopropanol / right: distilled water

2.1.5. Special Processes

2.1.5.1. Halogenation:

- For example process gas with fluorine can form permeation barriers.
Application: Fuel tanks
- Windscreen wipers can be chlorated to achieve greater smoothness.

2.1.5.2. Sterilization

Plasma can sterilise dry parts. The used process gas is oxygen or hydrogen peroxide.



fig. 64 a. 65: application examples: medical devices, cork for winebottles

2.1.5.3. Etching of PTFE

PTFE cannot be glued or printed without pre-treatment. For chemically wetted processes of surface treatment PTFE is etched with aggressive solutions of alkaline metal. Thereby a brown layer, capable of adhesion, is formed on the surface area. The process, however, is not easy to handle. Chemical solutions are liable to explosion and can be harmful to environment.

Pre-treatment with low-pressure plasma is an environmentally friendly alternative (fig. 66).

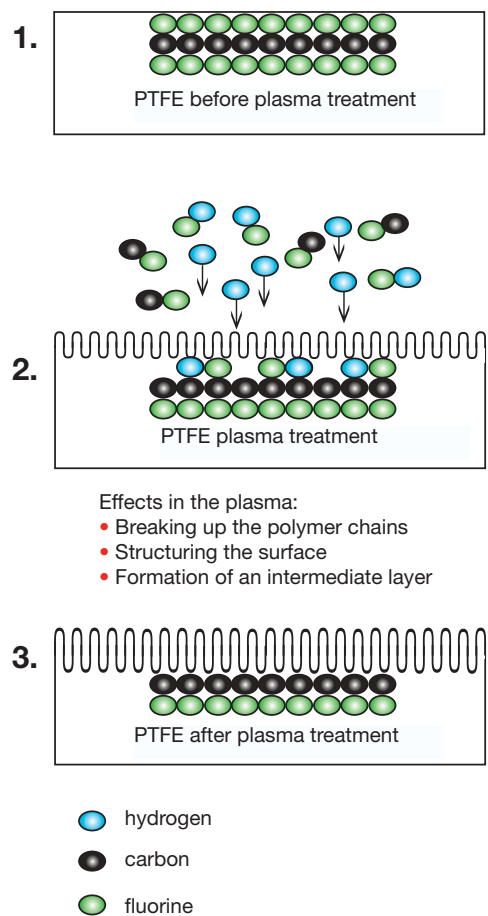

fig. 66: pre-treatment with low pressure plasma

The plasma process is structuring the surface area and hence enlarging it. In addition an intermediate layer is formed (fluorine on the surface area is reduced). By combining both effects the surface area can be glued and lacquered.

Example of an etched PTFE plate:



fig. 67: untreated PTFE plate



fig. 68: treated PTFE plate

The difference in colour between treated and untreated area is clearly visible. By means of colouring, etching strength can be seen. However, care must be taken that the material is not overtreated otherwise the opposite effect will occur.

2.1.5.4. Gluing of PTFE

Bonding of PTFE can be carried out by different gluing methods (fig. 69). A 2-component adhesive based on epoxy achieved very good results.

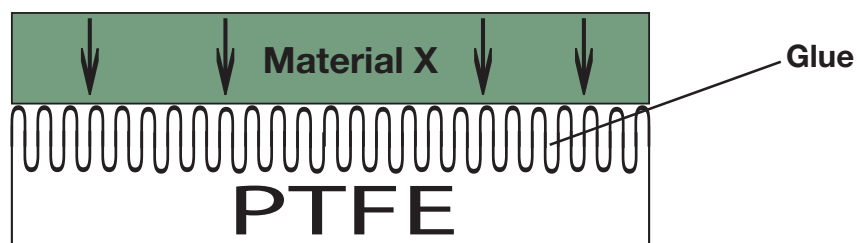

fig. 69: gluing PTFE



fig. 70: application example of gluing PTFE. treated PTFE is stuck together with a viton ring (Sealing).

2.1.5.5. Etching of PTFE-Compounds

In plasma etching of PTFE-compounds the area should not be etched too strongly, as this will expose the filler and hence adhesion is reduced.

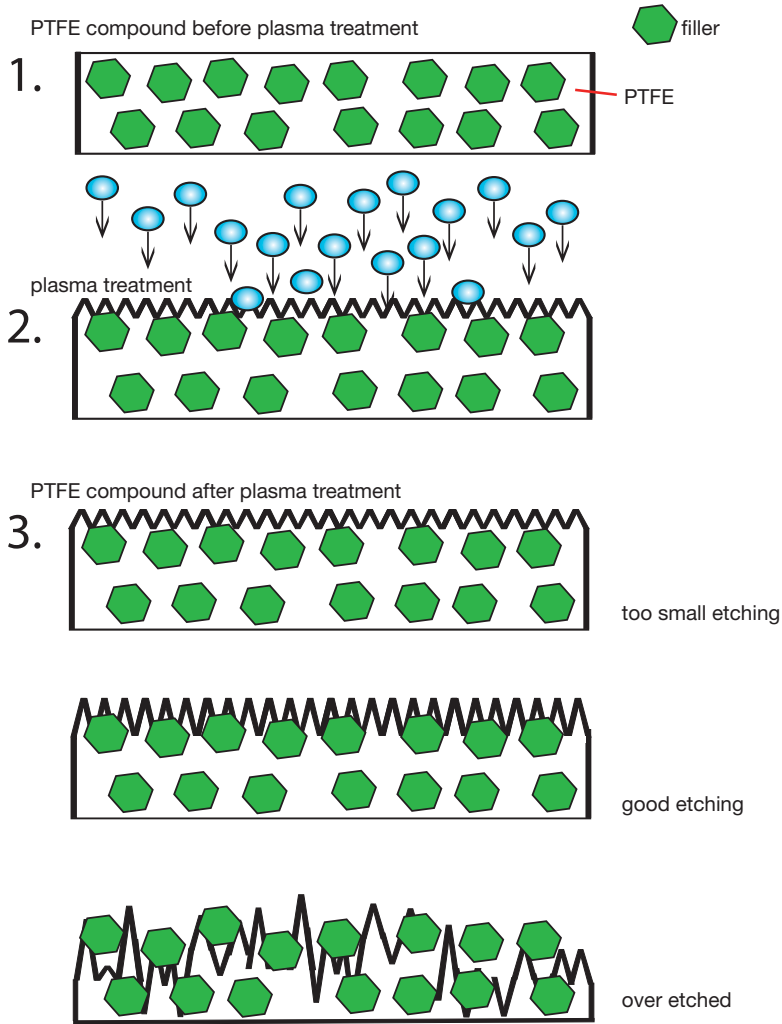

fig. 71: plasma etching of PTFE compounds

Examples of PTFE compounds:

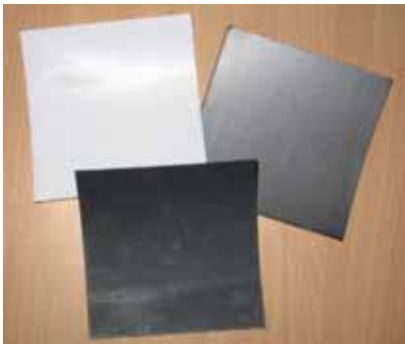

fig. 72, 73: examples of PTFE compounds without structure



fig. 74: structured with net

2.1.5.6. Epilam Coating (coating with PTFE)

Epilam coats are used in precision mechanics to prevent spread of lubricants.

Epilam coats can be produced in 2 different ways:

1. Fluorination: A suitable process gas containing **fluorine** surrounds components. This method is only suited to **plastic parts**. Fluorine atoms are deposited in the surface area of plastics and transform plastic into PTFE-like plastic.

2. Polymerization: By choice of suitable process gases very thin PTFE layers can be applied to components. This process is suitable for plastic- and metal parts.

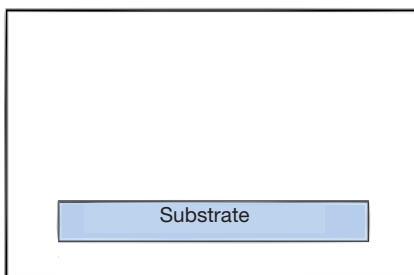

fig. 75: before plasma treatment

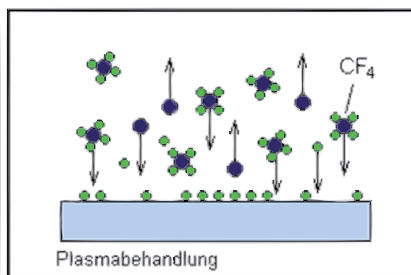

fig. 76: plasma treatment

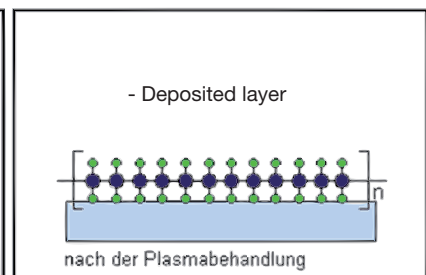

fig. 77: after plasma treatment

With **plastics both processes** run simultaneously. They can be controlled in one or the other direction by selection of process pressure and gas compositions. **Rotating drum** operation is possible.

Process times are approximate between 30sec and 10min.

All three standard frequencies (40kHz, 13.56MHz, 2.45GHz, see chapter 2.4.) are being considered.

Advantages:

- **No solvents** have to be used
- **Explosion protection is not** necessary
- Staff is not exposed to toxic chemicals
- Components do not need to be dried
- **Running costs** of the machine are **very low**
- Components **including carrier** can be treated

2.1.5.7. Coating by sputter process

Sputtering (“sputter coating”) also called cathode sputtering means ablation or in reference dusting of material from a solid by energetic ion bombardment with energetic ions to coat a substrate with the dusted material.

The magnetron sputtering process is a so-called PVD process (Physical Vapour Deposition). The stable vacuum coating process enables high consistency and purity of the coat. The source of coating (sputter source) is producing low-pressure plasma from inert gas (typically argon) in a vacuum chamber at a pressure in the region of 10^{-3} - 10^{-2} mbar. Starting point of material for the coat is the so-called target, which is found in the sputter source (see fig. 78).

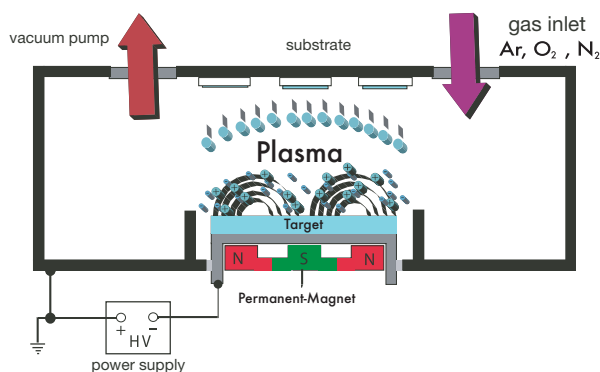

fig. 78: schematic illustration of magnetron sputter process with round geometry of the targets (bottom-up arrangement).

By supplying voltage (high frequency voltage generator) to the target, plasma is lit in the sputter source. Energetic ions, which are accelerated towards the target, meet there and particles are ablated. These particles deposit on the substrate to be coated and the layer is growing atom by atom. In addition, if reactive gases are entering into the plasma, these particles connect with the ablated particles from the target and the layer grows to a compound layer (reactive sputtering). For instance, to create titanium dioxide, titanium serves as a target material and oxygen as a reactive gas.

To strengthen the degree of ionisation and therefore rate of coating, field magnets are mounted behind the targets (magnetron-sputter, see fig. 78). Further field magnets can be stacked to control expansion of the plasma and influence growth of layer (balanced/unbalanced mode).

High kinetic energy of dusted atoms supports very good coat adhesion. The resulting coat possesses high homogeneity. Very smooth, dense and defect-free layers appear. In addition, ablation can be optimised by fitting a negative-bias voltage to the substrate. By attracting positive ions voltage can lead to even better adhesion, higher density and greater hardness of the coat.

Thermal loading of the substrate is less than ($T < 200$ C) which makes sputter technology a low-temperature process and hence enables coating of numerous materials (metals, alloys, polymers). Of course, less temperature sensitive materials (ceramics, glass) can also be coated by a sputter process.

Sputter technology works with all conductive materials as well as materials of high melting point; e.g. Al, Cr, Au, Ag, Ti, Stainless Steel (SS), Cu are only some of these materials. Also insulating materials can be dusted and used as target material.

By varying coating parameters in the magnetron sputter process, conditions of plasma and hence properties of the layer can be determined to a large extent. Thickness of coating can be precisely controlled. This supports better process repeatability. Flexible windows of process systems enable high stability of process. A typical thickness layer can reach from 1 nm to several μm . Moreover very different coat combinations can be exactly set.

Modern PVD devices have typically several sources of material (fig. 79) in order to produce very complex combinations- and structures of layer. Adding the possibility of reactive processes, sputter coating can deposit layers of metal, elements and compounds, multi-layers and alloys in the same manner.



fig. 79: view into the vacuum chamber of a sputtering coating system. You can see two sources of sputtering of cylindrical geometry here. During the coating process are the substrates under the sources on (swivelling) the plate (top down arrangement). For the in-situ control of the coating rate and the layer thickness are two independently working measuring systems installed.

The application of solid sources of material categorises PVD-processes into visible processes. Three-dimensional parts, which need coating, have to be able to rotate in the device to receive uniform coating. Target geometry of source of sputter could be round or rectangular up to several metres long.

Sources of material can be fitted free in space, as there is no molten phase when sputtering. In other words, sputter coating is independent of orientation (bottom-up, top-down and side-to-side).

The sputter process has obvious advantages in comparison to traditional processes like galvanisation or vaporisation in vacuum. For example compared to galvanisation it is a “clean technology” which entirely refrains from the use of hazardous substances. This avoids high operational- and waste disposal costs and offers the finish of a functional surface area a clean production alternative.

Sputter process technology has gained a high technical level and is also suited to mass production as a manufacturing process.

Conclusion:

Coating	Substrate Material
Hard Coating Wear Resistant Coating Decorative Coating Corrosion Resistant Coating Optical Coating Functional coating systems (conductive, insulating, hydrophilic, hydrophobic, biocompatible, easy-to-clean, barrier coating)	Metals Alloy Ceramics Glass Semi-conductive material Polymers

Advantages of this process
High flexibility with regard to possible materials of coating High flexibility with regard to possible methods of processes Controlled, reproducible layer deposition High homogeneity and purity of deposited layer High coating adhesion Systematic control of coating properties Independent orientation of coating source Environmentally friendly process

2.1.5.8. Coating with carbon layers

Carbon layers can reduce friction and wear considerably. Many components or tools can hereby be improved in their wearability. In many areas of mechanical engineering parts are required which are in one way very resistant on the surface and on the other extremely hard and of good mechanical strength. Typical examples are bush- and ball bearings, forming- and working tools or engine components.

On the basis of amorphous carbon compounds (DLC - Diamond Like Carbon) protective and functional coats can be produced which can combine these properties. Their impact on lowering friction is extreme; they have good hardness and above all outstanding wearability and are chemically inert. Tetrahedral amorphous carbon (ta-C) is described more closely as a "Diamond like Carbon" (DLC). It is also common to associate hydrogenous variations with this name.

Carbon layers consist mainly of carbon atoms. DLC layers are differentiated between hydrogen-based and hydrogen-free layers. In addition metallic or non-metallic elements can be incorporated into DLC layers.

Incorporation of metals is increasing adhesion on the substrate and toughness, however, diminishes friction value and hardness decreases. Non-metallic additives decrease surface energy and reduce adhesion and hence tendency to wetting, however, at reduced hardness and worse tribologic properties. Classification of carbon layers is stipulated under VDI-Guidelines 2840, table 1 shows an extract.

The proportion of sp^3 - and sp^2 hybridised C-atoms and amount of hydrogen is determining the type and properties of a carbon layer. A hard DLC has a hydrogen content of less than 10%. With the increase of sp^3 content hardness and elasticity modulus of layer increase. Because of its amorphous structure DLC is also described as a-C:H (amorphous carbon) and due to the involvement of ion at layer formation it is described as i-C (ion carbon). They are specially suited to tribological applications, coating of optical components as protective layer against diffusion or chemical attack and increase of biocompatibility of medical implants. It is possible to create amorphous carbon layers with very high content of sp^2 hybridised carbon. These are best suited as sliding layers (slick coating).

Table 1: Carbon layers in the overview (VDI guideline 2840)

carbon layers								
description	plasma polymer layers	Amorphous carbon layers (DLC)						
		hydrogen-free			containing hydrogen			
additives				modified			modified	
				with metal			with metal	with nonmetal
predominan kind of C-C connection	sp ³ / sp ² / sp ¹	sp ²	sp ³	sp ²	sp ² / sp ³	sp ³	sp ²	sp ²
separating procedure	plasma polymerisation	PVD	PVD	PVD	PA-CVD	PVD PA-CVD	PVD PA-CVD	PVD PA-CVD
recommended abbreviation		a-C	ta-C	a-C:Me	a-C:H	ta-C:H	a-C:H:Me	a-C:H:X

abbreviations: Me=W, Ti, ... (metal); X=Si, O, N, F, B, ... (nonmetal)

Manufacture of DLC coats is usually done by vacuum coating. These low-pressure coating processes are normally categorised into PVD- (Physical Vapour Deposition) and CVD process (Chemical Vapour Deposition). Coating material of PVD processes is a solid in its original form and is converted into gas by phase change i.e. by sputter, see chapter 2.1.5.7.). CVD processes exclusively use gases as original form of material.

For deposition of carbon plasma polymer films a PECVD processes (Plasma Enhanced Chemical Vapour Deposition) is used. For coating of DLC layers the PECVD process as well as PVD process (i.e. sputtering from a graphite target, see chapter 2.1.5.7.) can be suggested. Also a combination of both processes is possible, for example in deposition of metallic a-C:H:Me layers.

During the PECVD process chemical reactions in non-thermal plasma lead to layer deposition. Amorphous carbon layers are plasma supported by the PECVD process and are deposited from the hydrocarbon atmosphere. One of the electrodes serves as a carrier for the substrate to be coated.

The necessary ions forming the layer are accelerated by the low-pressure plasma towards the substrate and deposit there. This process is benefiting from the physical effect that the excited electrode is charging with a negative potential (self-bias) and hence ions in plasma get attracted. Depending on conditions of reaction hydrogen-rich polymers are deposited to hard layers with relatively little hydrogen content.

DLC coats are by nature subject to high inherent compressive stresses, which result from the continuation of energy-rich ion bombardment during growth of layer. These inherent compressive stresses are necessary to stabilise the layer within itself. On the other hand they limit adhesion and thickness of layer.

Depending on the substrate material adhesion problems can be solved by introducing an adhesive layer (enabled adhesive PVD interlayer) or in the case of DLC mono-layers (without interlayer) optimising the process parameter with regard to inherent stresses.

At present amorphous diamond-like-carbon coats (DLC) are used mainly to reduce wear and friction. Wetting by lubricants can be changed to a limited extent by incorporating elements for network modification. This, however, will influence other important properties of DLC coats like hardness, E-Modulus, tensile strength and friction value. Therefore, the application of network modifying elements in DLC coating of tribological applications and the potential for optimising layers is limited. Furthermore, the coexistence of DLC coats with lubricants is very little researched. As a rule those lubricants are used which have been applied successfully in comparatively uncoated systems. Research of systematic co-ordination of wetting of DLC coating by influence of topography is only known partially. It was shown that when structuring the surface area simultaneous chemical modification can systematically influence adhesion of lubricants. But restructuring was done by aid of different techniques and did not come from within the process. Trials to implement structure into DLC coating by post-processes like laser, electron beam radiation and lithographic techniques have not been successful. These expensive techniques are unable to create structures of a nanoscopic level or damage the layer or the substrate.

On the basis of multiple machine components and their geometric complexity, manufacture of tools and collets which create functional surfaces of adapted structures for service conditions is not practicable, in most cases even impossible.

Latest research shows that for tribologic use of areas of mixed friction such “rough” surface areas provide better properties than smooth ones. An investigation showed there is a correlation between topography of DLC coats and their behaviour under lubricated drum loading. At the same time it was proven that when a layer is manufactured accordingly it is permanently preserving surface area structure. Reliable use of these specially structured DLC coats and drastic expansion into tribologic advantages is only possible by targeting control of a structure and hence the continuous related development of coating processes.

For this purpose PECVD techniques were developed which exclude basic problems of this technology and target the structure of DLC coats from within the process (in-situ structure).

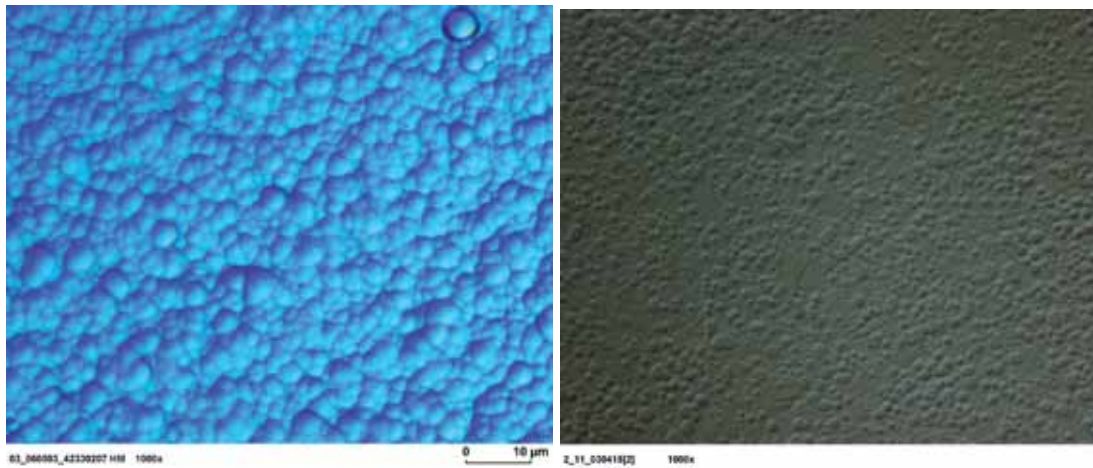

fig. 80: DLC layers with micro scale insitu-structure

Simultaneously it was proven that the surface structure is permanently remaining when coating is produced accordingly.

Depending on application DLC coats can be produced with nanoscopic structure or extreme slick. Also anisotropic growth of layer is feasible.

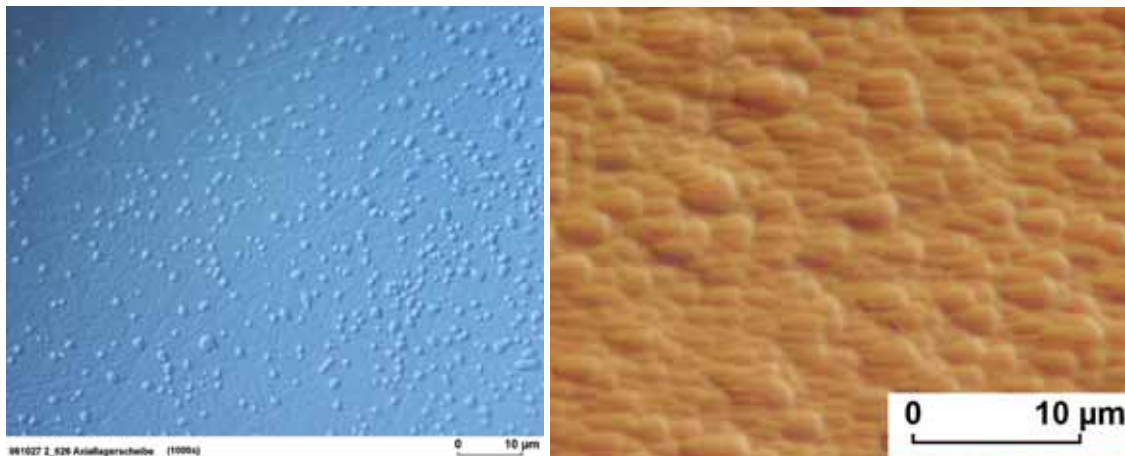

fig. 81: DLC layer with nano scale insitu structure

fig. 82: DLC layer with anisotropic micro and nano scale insitu structure („shark skin“)

To characterise these micro- and nanoscales of DLC coats, they are measured by AFM.

Typical characteristics of hydrocarbon layers are:

- **Thickness layer:** some nm -10m
- **Hardness:** is between 1 and 90GPa
- **Composition:** up to 50at.% hydrogen, 0-35 at% Me
(Fe, W, Ta, Ti, Si, Cr,....)
- **Microstructure:** amorphous
- **Compounds:** sp² , sp³ , sp¹ , in different ratios
- **Stability:** meta-stable
- **Electrical conductivity:** insulator
- **Density:** 1.8 - 2.8 g/cm³
- **Intrinsic Stress:** high compressive stresses
- **Band Gap:** 0.8 - 3eV
- **Friction Coefficient:** 0.01 - 0.3 (varying with humidity)
- **Low modulus of elasticity**
- **Good abrasion resistance under critical tear strain**
- **Low surface roughness**
- **Little thermal conductivity**
- **Little resistance to temperature (approx. 350° C)**
- **Little tendency to adhesion compared to most materials**
- **Chemically resistant**
- **Biocompatible**

2.2. Plasma Systems

2.2.1. Standard systems - Overview

All plasma systems can be a combination of most diverse types available. The following overview is listing most common plasma systems.

FEMTO

Basic equipment

Chamber volume	depending on version 1.9-2.8 ltr
Level(s)	1-2 pc
Voltage supply	230 VAC (120 VAC)
Gas connections	1 pc
Vacuum pump speed	min. 1,5 m ³ /hr



fig. 83: FEMTO Standard version

Equipment of variations

Plasma chamber	<ul style="list-style-type: none"> • Stainless steel Ø 100 mm, L 270 mm • Glass version (UHP) Ø 95 mm, L 270 mm Opening: Ø 90 mm • Rectangular version 100 x 100 mm, L 280 mm
Generator (See chapter 2.7.25.)	<ul style="list-style-type: none"> • LF (100 W) • RF manual (100 W) • RF automatic (100 W) • MW (260 W)
Control (See chapter 2.3.)	<ul style="list-style-type: none"> • Semi automatic • Automatic • PC-Control
Electrode (See chapter 2.7.14.)	<ul style="list-style-type: none"> • RIE • PE
Gas supply	<ul style="list-style-type: none"> • Needle valve • MFC
Further options	<ul style="list-style-type: none"> • Corrosive gas version • Rotary drum • Spare parts set • Monomer bottle • Heating plate / heating chamber • Additional needle valve made from brass or stainless steel • Pressure Gauge (Pirani) • Pressure Reducer • Gas bottle (Ar, H₂, O₂, CF₄) • Faraday-box • Multi-level electrode • Temperature indicator • Mass Flow Controller • Glass boat • ...



fig. 84: FEMTO with door



fig. 85: FEMTO PC

Technical modifications are subject to change

PICO

Basic equipment

Chamber volume	depending on version 4-8 ltr
Level(s)	1-3 pc
Voltage supply	230 VAC (120 VAC)
Gas connections	1-2 pc
Vacuum pump speed	min. 2,5 m ³ /hr

Equipment of variations

Plasma chamber	<ul style="list-style-type: none"> • Stainless steel Ø 150 mm, L 320 mm • Glass version (UHP) Ø 130 mm, L 300 mm Opening: Ø 125 mm • Rectangular version 160 x 160 mm, L 325 mm
Generator (See chapter 2.7.25.)	<ul style="list-style-type: none"> • LF (200 W) • RF manual (200 W) • RF automatic (200 W) • MW (260 W)
Control (See chapter 2.3.)	<ul style="list-style-type: none"> • Semi-automatic • Automatic • PC-Control
Electrode (See chapter 2.7.14.)	<ul style="list-style-type: none"> • RIE • PE
Gas supply	<ul style="list-style-type: none"> • Needle valv • MFC
Further options	<ul style="list-style-type: none"> • Corrosive gas version • Rotary drum • Spare parts set • Monomer bottle • Heating plate / heating chamber • Additional needle valve made from brass or stainless steel • Pressure Gauge (Pirani) • Pressure Reducer • Gas bottle (Ar, H₂, O₂, CF₄) • Faraday-box • Multi-level electrode • Temperature indicator • Mass Flow Controller • Glass boot • ...

Technical modifications are subject to change



fig. 86: PICO Standard version



fig. 87: PICO with door



fig. 88: PICO with door and PC-control

NANO

Basic equipment

Chamber volume	depending on version 18-24ltr
Level(s)	1-2 pc
Voltage supply	230 VAC (120 VAC)
Gas connections	2 pc
Vacuum pump speed	min. 8 m ³ /hr

Equipment of variations

Plasma chamber	<ul style="list-style-type: none"> • Stainless steel Ø 267 mm, L 420 mm • Glass version (UHP) Ø 240 mm, L 400 mm Opening: 210 mm
Generator (See chapter 2.7.25.)	<ul style="list-style-type: none"> • LF (300 W) • RF manual (300 W) • RF automatic (300 W) • MW (300 W)
Control (See chapter 2.3.)	<ul style="list-style-type: none"> • Semi-automatic • Automatic • PC-Control
Electrode (See chapter 2.7.14.)	<ul style="list-style-type: none"> • RIE • PE
Gas supply	<ul style="list-style-type: none"> • Needle valve • MFC
Further options	<ul style="list-style-type: none"> • Corrosive gas version • Rotary drum • Spare parts set • Monomer bottle • Heating plate / heating chamber • Additional needle valve made from brass or stainless steel • Pressure Gauge (Pirani) • Pressure Reducer • Gas bottle (Ar, H₂, O₂, CF₄) • Faraday-box • Multi-level electrode • Temperature indicator • Mass Flow Controller • Glass boat • ...

Technical modifications are subject to change



fig. 89: NANO Standard version



fig. 90: NANO with door

TETRA-30

Basic equipment

Chamber volume	depending on version 34-57 ltr
Level(s)	multi level electrode
Voltage supply	400 V, 3 phases
Gas connections	2 pc or more
Vacuum pump speed	min. 16 m ³ /hr

Equipment of variations

Plasma chamber	<ul style="list-style-type: none"> • Stainless steel, L x B x D: 305 x 300 x 370 mm • Stainless steel, enlarged: 305 x 300 x 625 mm
Generator (See chapter 2.7.25.)	<ul style="list-style-type: none"> • LF (1.000 W) • RF manual (300 W / 600 W) • RF automatic (300 W / 600 W) • MW (1.200 W)
Control (See chapter 2.3.)	<ul style="list-style-type: none"> • Semi-automatic • Automatic • PC-Control
Electrode (See chapter 2.7.14.)	<ul style="list-style-type: none"> • RIE • PE
Gas supply	<ul style="list-style-type: none"> • Needle valve • MFC
Further options	<ul style="list-style-type: none"> • Corrosive gas version • Rotary drum • Spare parts set • Monomer bottle • Heating plate / heating chamber • Additional needle valve made from brass or stainless steel • Pressure Gauge (Pirani) • Pressure Reducer • Gas bottle (Ar, H2, O2, CF 4) • Faraday-box • Multi-level electrode • Temperature indicator • Mass Flow Controller • Glass boat • ...

Technical modifications are subject to change



fig. 91: TETRA-30-LF Standard version



fig. 92: TETRA-30-LF-PC with PC-Control

TETRA-100

Basic equipment

Chamber volume	approx. 100 ltr
Level(s)	multi level electrode
Voltage supply	400 V, 3 phase
Gas connections	2 pc or more
vacuum pump speed	min. 40 m ³ /hr

Equipment of variations

Plasma chamber	<ul style="list-style-type: none"> Stainless steel, L x B x D: 400 x 400 x 625 mm
Generator (See chapter 2.7.25)	<ul style="list-style-type: none"> LF (1.500 W) RF manual (600 W) RF automatic (600 W) MW (1.200 W)
Control (See chapter 2.3)	<ul style="list-style-type: none"> Semi automatic Automatic PC-Control
Electrode (See chapter 2.7.14)	<ul style="list-style-type: none"> RIE PE
Gas supply	<ul style="list-style-type: none"> Needle valve MFC
Further options	<ul style="list-style-type: none"> Corrosive gas version Rotary drum Spare parts set Monomer bottle Heating plate / heating chamber Additional needle valve made from brass or stainless steel Pressure Gauge (Pirani) Pressure Reducer Gas bottle (Ar, H₂, O₂, CF₄) Faraday-box Multi-level electrode Temperature indicator Mass Flow Controller Glass boat ...

Technical modifications are subject to change



fig. 93: TETRA-100-LF Standard version



fig. 94: TETRA-100-LF-PC with PC-Control

TETRA-150

Basic equipment

Chamber volume	approx. 150 ltr
Level(s)	multi level electrode
Voltage supply	400 V, 3 phase
gas connection	2 pc or more
Vacuum pump speed	min. 65 m ³ /hr

Equipment of variations

Plasma chamber	<ul style="list-style-type: none"> Stainless steel, L x B x D: 600 x 400 x 625 mm
Generator (See chapter 2.7.25)	<ul style="list-style-type: none"> LF (2.500 W) RF manual (1.000 W) RF automatic (1.000 W) MW (1.200 W)
Control (See chapter 2.3)	<ul style="list-style-type: none"> Semi automatic Automatic PC-Control
Electrode (See chapter 2.7.14)	<ul style="list-style-type: none"> RIE PE
Gas supply	<ul style="list-style-type: none"> Needle valve MFC
Further options	<ul style="list-style-type: none"> Corrosive gas version Rotary drum Spare parts set Monomer bottle Heating plate / heating chamber Additional needle valve made from brass or stainless steel Pressure Gauge (Pirani) Pressure Reducer Gas bottle (Ar, H2, O2, CF 4) Faraday-box Multi-level electrode Temperature indicator Mass Flow Controller Glass boat ...

Technical modifications are subject to change



fig. 95: TETRA-150-LF Standard version



fig. 96: TETRA-150-LF-PC with PC-Control

2.2.2. Large- and Special Systems

We also build plasma systems according to your needs. The systems follow the conceptual point of views:

- Expected output and yield
- Size of parts to be treated

Examples of projects undertaken:

Special system TETRA-120-LF:

The pre-treatment system TETRA-120 with **120 litres chamber volume** and fully automatic door is mainly used for serial production (components for mobile telephones).



fig. 97: TETRA-120-LF

Special system TETRA-500-LF-PC:

The production system TETRA-500-LF-PC with **500 litres chamber volume**, PC control and fully automatic door is mainly used for serial production (plastics activation).



fig. 98: plasma system TETRA-400-LF-PC, door opened



fig. 99: plasma system TETRA-400-LF-PC door closed

Special system TETRA-600-LF-PC:

The production system TETRA-600 with **600 litres chamber volume** and PC control is mainly used for serial production (cleaning, etching and activation).



fig. 100: plasma system TETRA-600-LF-PC (opened)



fig. 101: plasma system TETRA-600-LF-PC (closed)

Special system TETRA-600-LF-PC with rotary drum:

The production system TETRA-600 with **600 litres chamber volume** and PC control is mainly used for serial production (cleaning, etching and activation).



fig. 102: plasma system TETRA-600-LF-PC
with rotary drum (closed)



fig. 103: plasma system TETRA-600-LF-PC
with rotary drum (opened)

Special system TETRA-2400-LF-PC:

The production system TETRA-2400 with **2.400 litres chamber volume** and PC-control is mainly used for serial production (cleaning, etching and activation).



fig. 104: plasma system TETRA-2400-LF-PC designed for the production

Special system TETRA-5600-LF-PC:

The production system TETRA-5600 with **5.600 litres chamber volume** is based at Diener Electronic and among other things is used for process development .



fig. 105: plasma system TETRA-5600-LF (opened)



fig. 106: plasma system TETRA-5600-LF (closed)

Special system TETRA-12.600-LF-PC:

The production system TETRA-12.600 with **12.600 litres chamber volume** and PC-control is mainly used for serial production (cleaning and activation).



fig. 107: plasma system TETRA-12600-LF-PC (opened)



fig. 108: filling plasma system with roll car



fig. 109: plasma system TETRA-12600-LF-PC (closed)



fig. 110: plasma in TETRA-12600-LF-PC (plastics on activation)

2.3. Controls

2.3.1. Process sequence

There are **5 process steps** for all machines independent of the type of control.

- | | |
|---------------------------------|---|
| 1. Pumping out: | Recipient is evacuated at lower pumping-out pressure |
| 2. Gas stabilising time: | Gas is let in and pressure stabilises |
| 3. Process time: | HF Generator is switched on |
| 4. Flushing time: | Pump runs and purging gas flows in (i.e. air)
Potentially harmful process gases are purged out of the chamber. |
| 5. Venting: | The chamber is filled with air. It is not pumped out. |

Following three controls are possible:

- Semi-automatic control
- Fully automatic control
- PC-control

2.3.2. Semi-automatic (manual) control

Individual process steps are set by operator manually:

1. Switch on pump
2. Switch on process gases
3. Set time
4. Set power
5. Start generator
6. Flushing
7. Venting

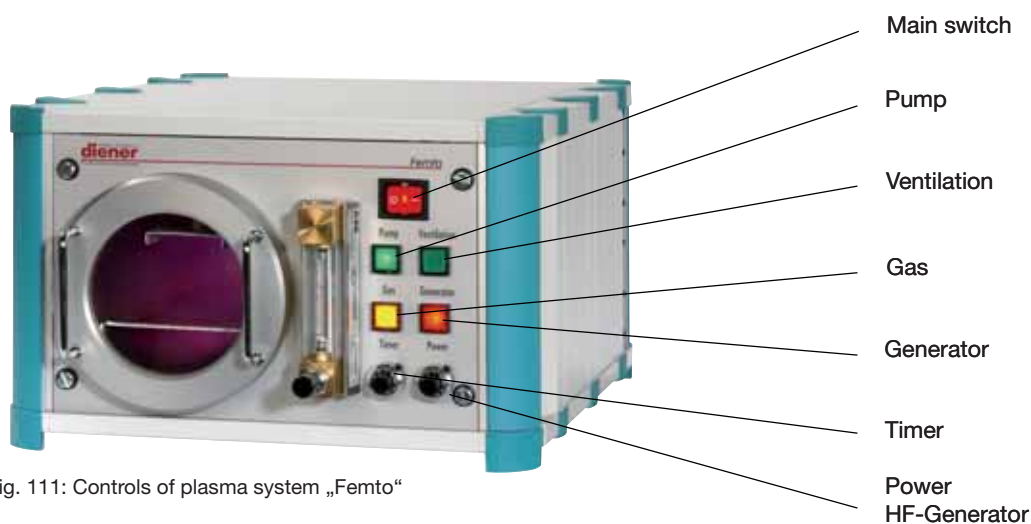

fig. 111: Controls of plasma system „Femto“

2.3.3. Fully automatic control

This type of control is particularly simple to operate by **one-button operation**. Single process steps are indicated by signal lights. Analog values for HF power and process pressure are indicated by **analog measuring instruments**.

Parameters, which can be set by operator:

- **Type of gas**
- **Process pressure**
- **HF power**
- **Process time**



fig. 112: controls of a TETRA Plasma system

2.3.4. PC-Control

This type of control is also simple to operate as operation command is via **windows**:

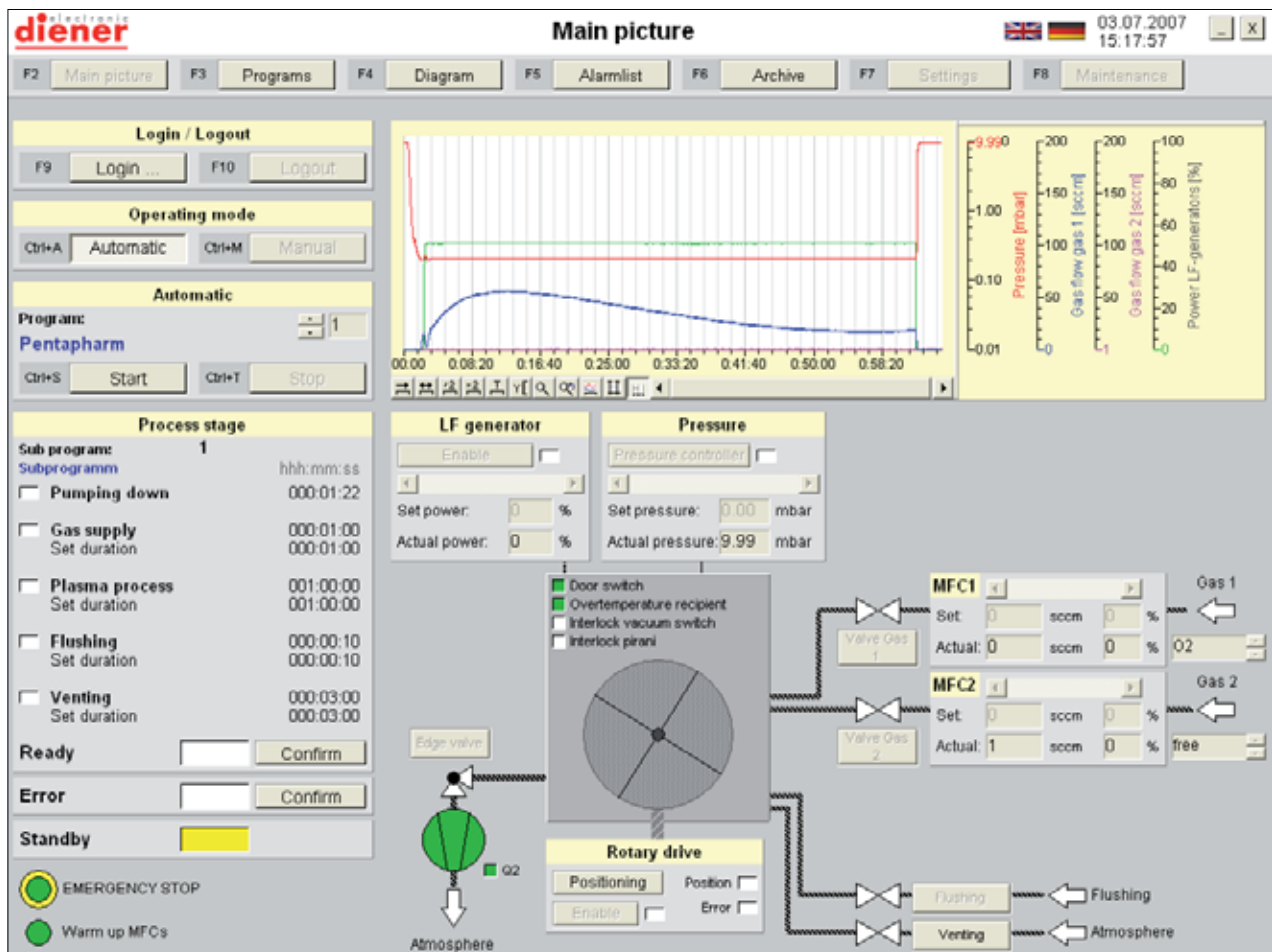

fig. 113: view process documentation

PC-control is especially intended for those users:

- Where **documentation of process** is important (certified companies) or
- Where users need many different processes. This control type can store **up to 100 processes**.

All conceivable **possibilities of error** are recorded by the control system. Control can be engaged by two different modes:

-Manuel operation: Manuel operation of the machine via dialog box

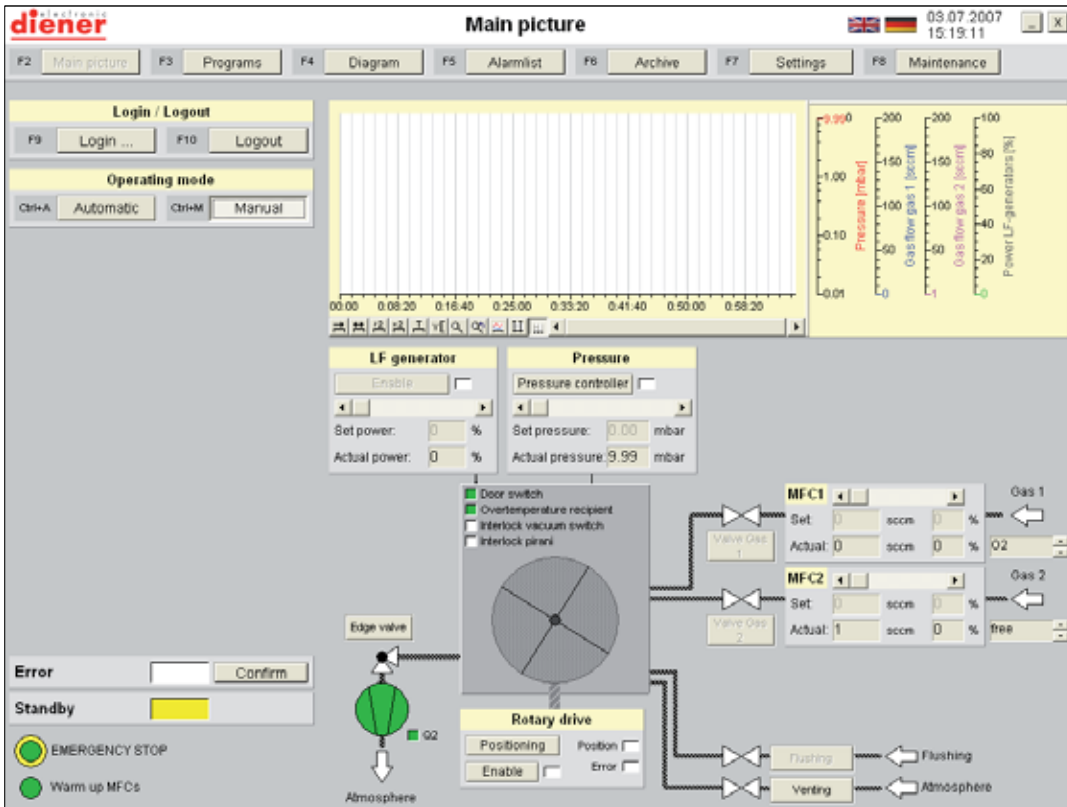

fig. 114: manual operation

- Automatic operation: Automatic workflow of a previously entered process



fig. 115: programming

Parameters which the operator can set :

- Pumping off pressure (up to process start)
- Max. pumping off time
- Gas mass flows
- Process pressure
- Stabilizing time
- HF power
- Process duration with HF
- Purging time
- Venting time
- Gas type
- Error limits

Possible evaluations:

- All process measurements are displayed graphically and can be printed out by traditional printers. Comments can be added. All stored processes including alarm list and data info can be viewed in the archive at all times.

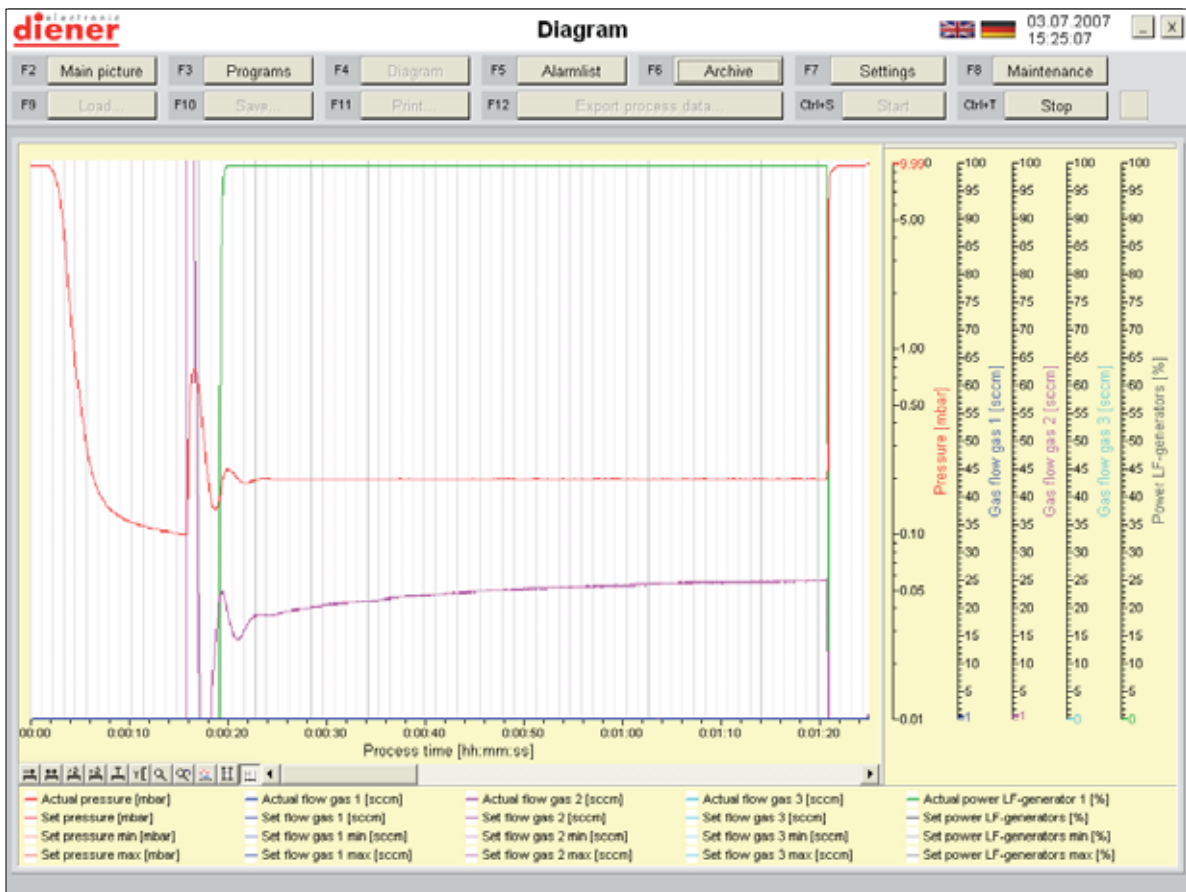

fig. 116: archive view of an plasma process

- Pressure can be regulated by a digital **PID regulator**
- All process data can be saved as **excel files**

If chosen, **end of process is indicated by sound.**

Gas flow can be controlled very precisely by **mass-flow controllers**, which is not possible with needle valves.

Additional functions, e.g. additional display of bias voltage or temperature are easily implemented into this control system in particular.

Control systems can be obtained in **English, French and other languages** on demand.

2.4. Which frequency is the best frequency?

This question cannot be answered straightforwardly but requires looking into case by case. At present there is a trend towards kHz generators. KHz machines can treat approximate 90% of all customer parts.

The following overview may **help** in your **decision**:

Frequency 40 kHz:

Advantages:	Disadvantages:
Most inexpensive solution	At same etching rate, more power is needed than at 13.56 MHz
Robust	Only passivated semiconductors can be cleaned prior to bonding.
Potential-free coupling can render maximum homogeneity at all 3 frequencies.	Only under certain circumstances suitable for semiconductor front-end processes
Metal rotating drums can be used without problems.	
RIE operation is possible (high etching rate)	
Impedance adaptation requires no mechanical components prone to interference.	
Efficiency factor approx. 80%	
Electrodes/carrier rack of 10 or more can be fitted to achieve very high throughput.	
Suited well to semiconductor back-end processes	
Lower coating rates in plasma polymerization processes.	
Generators are easily repaired.	

Frequency 13,56 MHz

Advantages:
RIE operation possible
Homogeneity is better than at 2,45 GHz
Etching rate is higher than at 40 kHz at same power
Metal rotating drums can be used without problems
Electrodes/carriers can be stacked, symmetry of electrodes is, however, very important
Suited to front- and back-end semiconductor processes
High coating rates in plasma polymerization processes

Disadvantages:
Extremely expensive
relatively prone to interference
Impedance adaptation by mechanically movable parts
HF system consists of generator and matching
Efficiency factor ca 50%
High amount of cabling
Generator repairs are expensive

Frequency 2,45 GHz:

Advantages:
Inexpensive
Relatively robust
Highest etching rate at same power
Efficiency factor approx. 60%
ECR operation possible (high etching rate)
Well suited to semiconductor front-end and back-end processes
High coating rates in plasma polymerization processes
Generators are easily repaired

Disadvantages:
HF system consists of power supply connector and coupling
High amount of cabling
Quartz disc has to be cooled
Glass- and ceramic components
Magnetron requires voltage of 4500V
Metal rotating drums can only be used under certain circumstances
Due to small wavelength (12cm) plasma is not homogeneous

2.5. Running costs of a plasma system

2.5.1. Example 1: Decreasing and activation by plasma system TETRA-100-LF (costs of one process)

Loading: Stack of 6 plastic parts
One level has a size of ca 350 x 580 mm
The parts can take up a maximum volume of a total of ca 20 - 40 ltrs.

Length of cycle: 20 min

Cost Overview:

Type of cost	Calculation	Cost per process
Depreciation	Annual depreciation of EUR 10,000 230 man-hours per year 8hrs daily working time (1-rota operation) Working time per year: $230 \times 8 \times 60 \text{ min} = 110,400 \text{ min}$ Per process: $\text{EUR } 10,000 / 110,400 \times 20 \text{ min} = \text{EUR } 1.81$	EUR 1.81
Cost of gas	Process gas: Oxygen Consumption: ca 0.1 ltr/min Gas consumption (treating time): 15 min 1.5ltr/process Cost per 10,000ltrs oxygen: ca EUR 40.00 Per process: $\text{EUR } 40 / 10,000\text{ltrs} \times 1.5 \text{ ltr} = \text{EUR } 0.006$	EUR 0,01
Cost of electricity	Average power during a process: $P = \text{ca } 2.5 \text{ kWh}$ Total process time: 20 min Energy: $W = P \times t = 2.5 \text{ kW} \times 1/3\text{h} = 0.83 \text{ kWh}$ Price of electricity: EUR 0.11 / kWh* Cost of electricity: $0.83 \text{ kWh} \times \text{EUR } 0.11 = \text{EUR } 0.09$	EUR 0,09
Cooling water	No consumption	EUR 0,00
Compressed air	No consumption	EUR 0,00
Maintenance	Empirical value: EUR 2,000 230 working days per year 8hrs daily working time (single rota operation) Working time per year: $230 \times 8 \times 60 \text{ min} = 110,400 \text{ min}$ Per process: $\text{EUR } 2,000 / 110,400 \times 20 \text{ min} = \text{EUR } 0.36$	EUR 0,36
Running machine cost for this process (incl. depreciation)		EUR 2,27

* average price of electricity of the industry incl. electricity tax for 2006

Source: Verband der Elektrizitätswirtschaft Baden-Württemberg e.V.

(Association of electricity boards Baden -Württemberg)

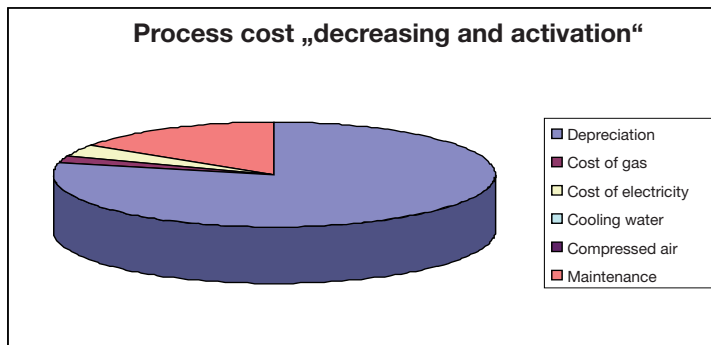

2.5.2. Example 2: Epilam Coating (Coating with PTFE) by plasma system TETRA-100- LF (cost of one process)

Loading: See example 1
 Length of cycle: 20 min

Cost Overview:

Type of cost	Calculation	Cost per process
Depreciation	see example 1	EUR 1,81
Cost of gas	Process gas: e.g. CF ₄ Consumption: ca 0.1ltr/min Gas consumption (treating time): 15 min 1.5ltr/process Cost per 6,500ltr process gas: approx. EUR 1,500.00. Per process: EUR 1,500 / 6,500ltr x 1.5ltr = EUR 0.35	EUR 0,35
Cost of electricity	see example 1	EUR 0,09
Cooling water	No consumption	EUR 0,00
Compressed air	No consumption	EUR 0,00
Maintenance	see example 1	EUR 0,36
Running machine cost for this process (incl. depreciation)		EUR 2,61

* average price of electricity of the industry incl. electricity tax for 2006
 Source: Verband der Elektrizitätswirtschaft Baden-Württemberg e.V.
 (Association of electricity boards Baden -Württemberg)

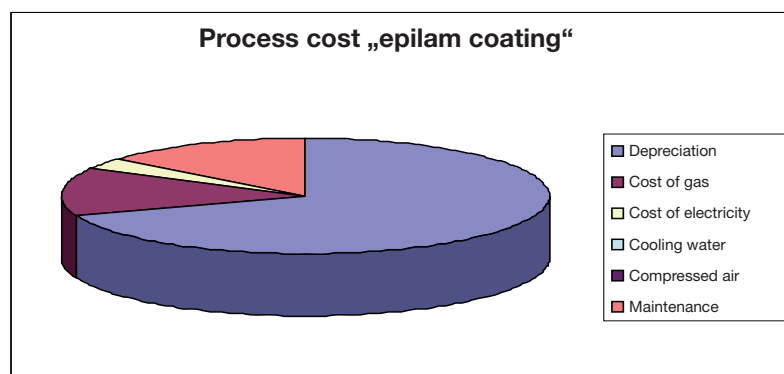

2.6. Vacuum Pumps

Vacuum pumps create the vacuum in the recipient of the plasma system.

Most frequently used vacuum pumps in plasma systems are:

2.6.1. Rotary Vane Pump



fig. 117: Oerlikon (formerly Leybold) rotary vane pump D16BCS

2.6.1.1. Method of operation

The rotary vane pump consists of a housing with an eccentrically mounted rotor rotating. Spring loaded vanes in the rotor are pushed against the inner wall of the housing where they slide along. The enclosed gas on the suction side is compressed until it exceeds surrounding pressure and outlet valve on the pressure side is opening.

The pump is running in an oil bath. This has the following advantages:

- a) Sealing off suction and pressure side
- b) Friction reduction

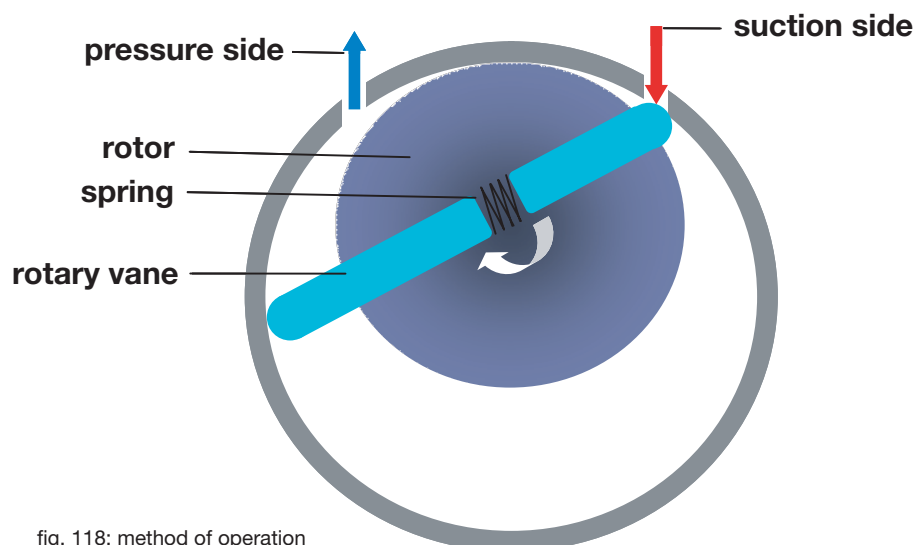

fig. 118: method of operation

2.6.1.2. Size of pump

Our standard systems are preferably equipped with rotary vane pumps. The bigger the pump, the shorter the process time.

Following pump sizes can be supplied by a leading manufacturer of vacuum pumps, e.g. Oerlikon (formerly Leybold):

Name of pump	Pumping speed
S 1,5	1,5 m ³ /h
D 2,5 E	2,5 m ³ /h
D 4 B	4 m ³ /h
D 8 B	8 m ³ /h
D 16 B	16 m ³ /h
D 25 B	25 m ³ /h
D 40 B	40 m ³ /h
D 65 B	65 m ³ /h

Some treated components are very gaseous (i.e. POM-parts, silicone rubber or damp parts). In this case it is recommended to use a stronger pump. This has to be clarified at pre-tests.

2.6.1.3. Handling of oxygen

If working gas is **oxygen**, vacuum pumps have to be prepared for it. In the pump casing **oil mist** is created. If mineral oil is in use, this mist becomes **explosive** as a pure oxygen compound.

There are **two possibilities** to solve this problem:

1. Vacuum pumps are filled with **PFPE oil**. This oil is **non-flammable**. However, it has major disadvantages:

- PFPE oil is extremely **expensive** (1ltr costs more than € 400,00)
- PFPE oil contains fluorine. During processes of plasma this oil is **broken down** and extreme toxic compounds can be formed (e.g. perfluoroisobutylene, PFIB). Such oil compounds have already caused dangerous accidents.
- PFPE oil must be disposed of as **hazardous waste**.

2. Vacuum pumps are flushed with air or N₂. This solution should be given preference.

Method of operation:

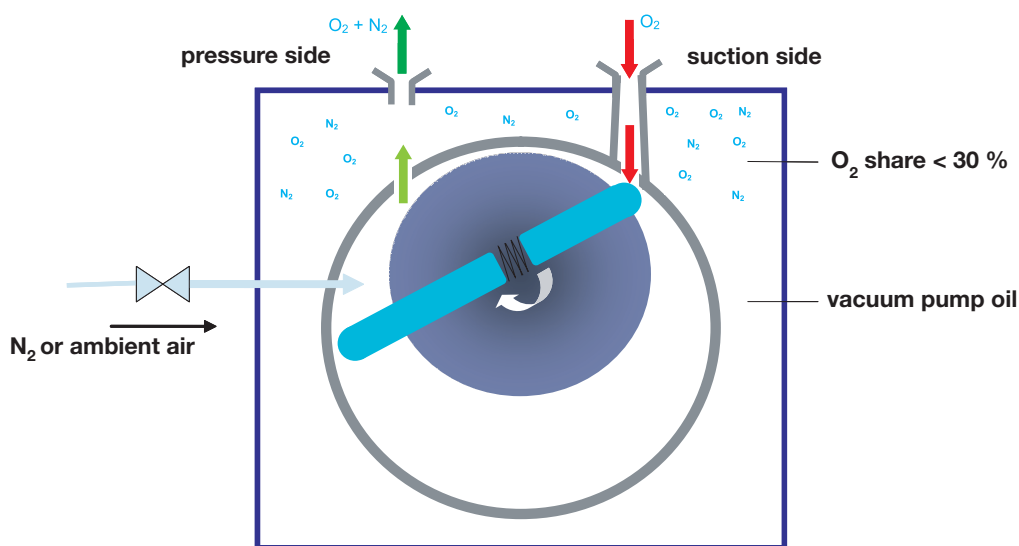

fig. 119: method of operation for air flushing

Should there be the danger of toxic compound formation during processes the pump has to be fitted with a **filter**. For example, this is the case in all processes including tetrafluoromethane.

2.6.1.4. Working with corrosive gases

Special vacuum pumps were developed for corrosive gas duties (CF₄ / O₂, SF₆,...). Following pumps by Oerlikon are suited to many applications:

Name of pump	Pumping speed
D 16 BCS	16 m ³ /h
D 25 BCS	25 m ³ /h
D 40 BCS	40 m ³ /h
D 65 BCS	65 m ³ /h

Frequent use of corrosive gases in vacuum pumps does limit their life span. For laboratory use one pump of this type is generally sufficient. However, for frequent use in production we advise to invest in a dry running vacuum pump .

Corrosive gas: Flush with dry air or nitrogen

2.6.2. Dry running vacuum pumps for corrosive gas processes

In this application we made good experiences with dry screw vacuum pumps manufactured by Busch (e.g. type Cobra).

We would be pleased to advise you which vacuum pump is best suited to your processes.



fig. 120: Busch-Pump Cobra BC 100
(with kindly permission of Dr.-Ing. K. Busch GmbH)

2.6.3. Roots Pump

Rotary vane vacuum pumps create limited pressure. To boost pump speed a combination with a roots pump is recommended. These form a so-called pump stand. A typical combination could be as follows:

1. First pump (e.g. rotary vane pump) creates a fore vacuum. This is described as the “forepump”.

2. As a second pump the roots pump is used.



fig. 121: Oerlikon Screwline 630

Cross-sectional area schematic of a roots pump:

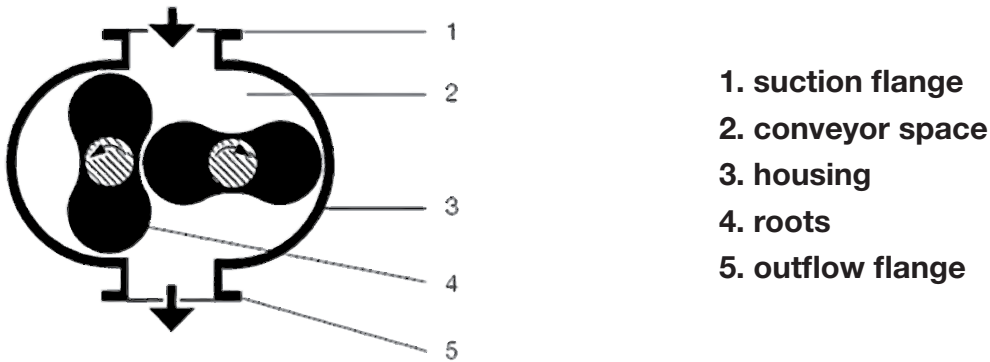

fig. 122: schematic cut of a roots pump

Functional schematic of roots pump

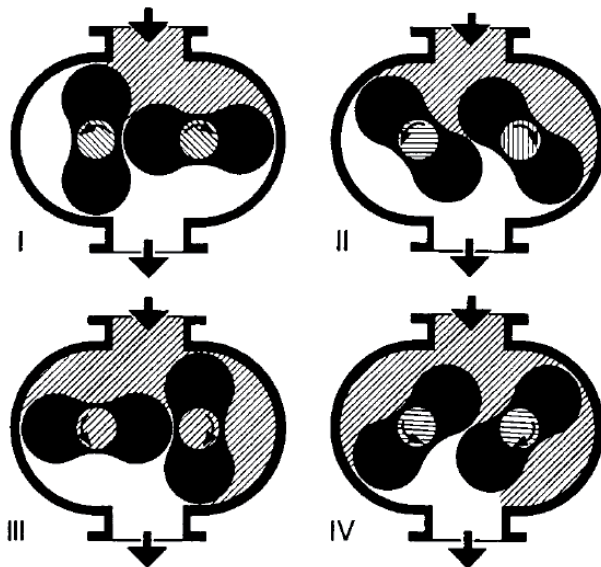

fig. 123: method of function of a roots pump

Principle of functioning

Roots pumps or known as roots blowers are rotary vane pumps with two vanes on an eccentrically mounted rotor opposite each other pushing out towards the inner wall of the casing.

Rotors form roughly an 8-shaped cross sectional area and are synchronised by a gear transmission so they can pass each other without touching and with little clearance the casing wall.

At rotor vane setting I and II the existing volume in the pump suction flange is getting enlarged. Turning vanes further to setting III one part of the volume is sealed off from the suction flange.

At setting IV this volume is released to the outlet and gas of fore vacuum pressure (higher than pumping in pressure) is let in. Inflowing gas is compressing the gas volume supplied by suction. Further turning of vanes releases compressed gas to outflow flange.

This process repeats itself for each of the two vanes twice per each revolution. Rotary vane pumps can be operated at high speed of revolution due to clearance between rotor and casing wall. This allows for a comparatively high suction to small pump ratio.

The pressure differential and compression ratio between suction inlet (pump in) and outlet are limited in rotary vane pumps.

(text and images by courtesy of Oerlikon Vacuum GmbH)

Schematic View:

Suction performance with and without rotary vane vacuum pump

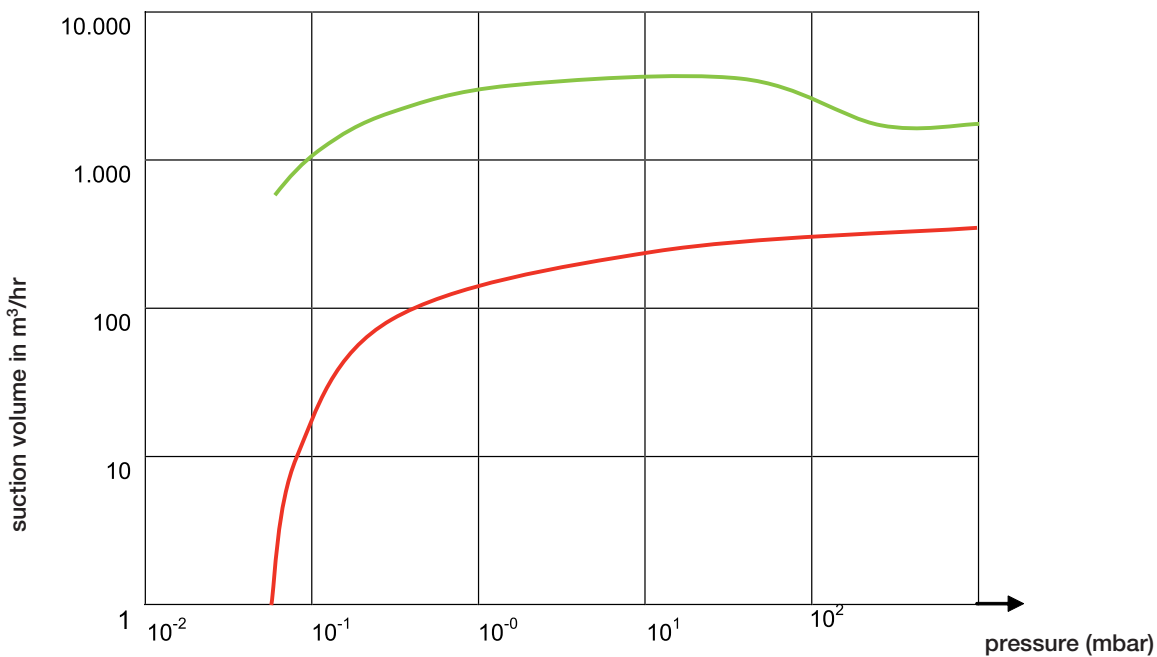

Suction performance with a rotary vane pump

Suction performance in combination rotary vane pump + roots pump

2.7. Supplied options

2.7.1. Rotary drum

Rotary drums are used especially for production of bulk material (small parts at high volumes).

Our standard rotary drums are made from perforated stainless steel (hole pattern), where size of hole can be varied.

Measurements of different rotary drums:

Plasma system	\varnothing	h	$V_{\text{rotary drum}}$	useful volume
	(mm)	(mm)	V_{Total} (ltr)	V_{Max} (ltr)
FEMTO	50 x 50 (angular)	110	0,3	0,1 - 0,15
PICO	110	258	2,5	0,83 - 1,25
NANO	210	258	8,9	3 - 4,45
TETRA-30	278	295	approx. 18	6 - 9
TETRA-30 (long) / TETRA-50	278	490	approx. 30	10 - 15
TETRA-100	378	490	approx. 55	18,3 - 27,5
TETRA-150	378	490	approx. 55	18,3 - 27,5

Technical modifications are subject to change

Rotary drums can be filled up to maximum 50% of their volume. Best results, however, are achieved when you fill them only to 1/3.

Customised construction is possible after agreement at any time.



fig. 124: rotary drum for Pico



fig. 125: rotary drum for Nano (open, built-in)

Rotary drums made from glass

These rotary drums are mainly used for plasma treatment of powder and other particles.



fig. 126: carrier (in plasma)

2.7.2. Spare part kit

Size and outline is depending on each plasma system. A medium sized system contains the following standard spare part kit:



1. Vacuum tube
2. Oil for vacuum pump (1 ltr)
3. Clamping ring + seal
4. Window pane
5. Miniature fuses (Qty: 10 pcs)
6. Window seal
7. Door seal

Abb 127: spare part kit

2.7.3. Additional gas channels

Depending on system, one (FEMTO) up to three gas channels (TETRA-30, TETRA-100,...) are installed as standard. However, there is the opportunity to have as many gas connections installed as requested.

Manual and semiautomatic plasma systems (laboratory machines) are fitted with needle valves as standard.

PC controlled systems have MFCs (Mass Flow Controllers). MFCs are available in all types of systems on demand.



fig. 128: MFC



fig. 129: Needle valve

One of the available suppliers we use is MKS Instruments. For further information please feel free to contact suppliers.

2.7.4. Polymerization Accessories

Part of the polymerization accessories are evaporator bottle (for liquid monomers), a scale (to control weight of monomer bottle during process) a dosing pump, heaters (to heat the chamber sufficiently so the monomer reaches the chamber in the gas phase), possibly a holder for the monomer bottle.



fig. 130: evaporator bottles



fig. 131: scale

2.7.5. Measurement of bias voltage

During operation carriers get charged negatively. By measurement of bias voltage it can be shown if plasma is ignited or not.

2.7.6. Automatic door

Example of implemented system with automatic door



fig. 132 u 133: system with automatic door

2.7.7. Special flange / additional flange

In our production we use mainly flanges of sizes KF 16, KF 25, KF 40.

ISO-K flanges are particularly used in large pumps.



fig. 134: KF flanges

ISO-K Flange



fig. 135: ISO-K flange (middle)

2.7.8. Safety valve

In the case of flammable gases in use (H_2 , C_2H_2), we install a safety valve for your protection.

2.7.9. Network connection

PC controlled plasma systems can be integrated into a network.

2.7.10. Maintenance service

Following tasks are carried out under our maintenance service:

- Operational- and safety relevant check of single components according to operating instructions
- Check of entire operation of plasma system
- Oil change
- Instructing staff of employer on system technical function and process engineering.

2.7.11. Hot plates

Heating the chamber with hot plates can increase etching rate (more consistent results).

2.7.12. Pressure Reducers

Process gas in use is contained in gas bottles, which are under pressure. A pressure reducer is a valve which can lower pressure of process gas to a required level.

Hydrogen pressure reducers are suitable for most flammable gases (apart from carbon monoxide and acetylene); you can recognise these pressure reducers by the connection with a left-hand thread and the grooves of the threaded fastener.

Flange connectors according to DIN 477

Connection-No.	Admitted gas types	Threads
1	methane, silane, hydrogen	W 21,80 x 1/14" LH
3	acetylene	connection for clamps
5	carbon monoxide	1" LH
6	ammonia, argon, helium, hexafluoroethane, carbon dioxide, sulphur hexafluoride, tetrafluoromethane	W 21,80 x 1/14"
8	hydrogen chloride, nitrogen dioxide	1"
9	oxygen	G 3/4"
10	nitrogen	W 24,32 x 1/14"



fig. 136: pressure reducer

2.7.13. Customised carriers / electrodes

Electrodes for laboratory machines:

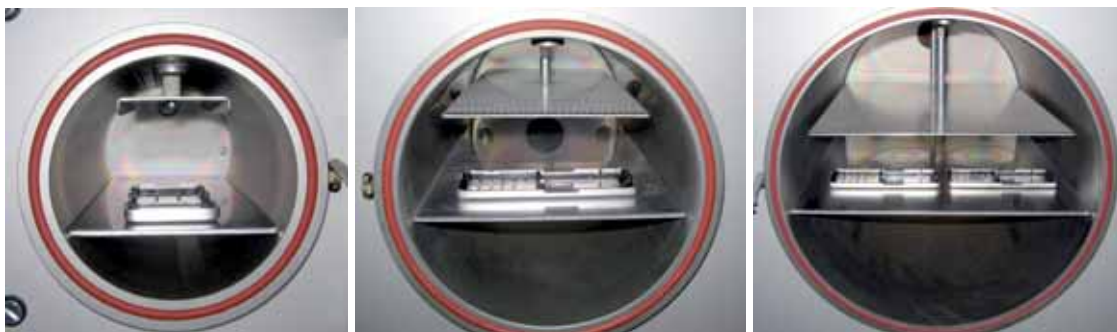

fig. 137: electrode in Femto

fig. 138: electrode in Pico

fig. 139: electrode in Nano



fig. 140: TETRA-30, multi level electrode fig. 141: TETRA-30, electrode for leadframes

Electrodes for wage labour:



fig. 142: TETRA-100, multi level electrode



fig. 143: TETRA-150, special electrode for pcb



fig. 144: TETRA-5600, multi level electrode

Carriers:

Carriers are always adapted to customer requirements. In general a carrier is represented by a simple stainless steel sheet but customised versions of carriers can also be produced.



fig. 145: Standard carrier



fig. 146: carrier for Leadframes



fig. 147: carrier for catheter



fig. 148: carrier for PCB

2.7.14. RIE electrode

Difference between PE (Plasma Etch) operation and RIE (Reactive Ion Etching) operation:

2.7.14.1. PE operation

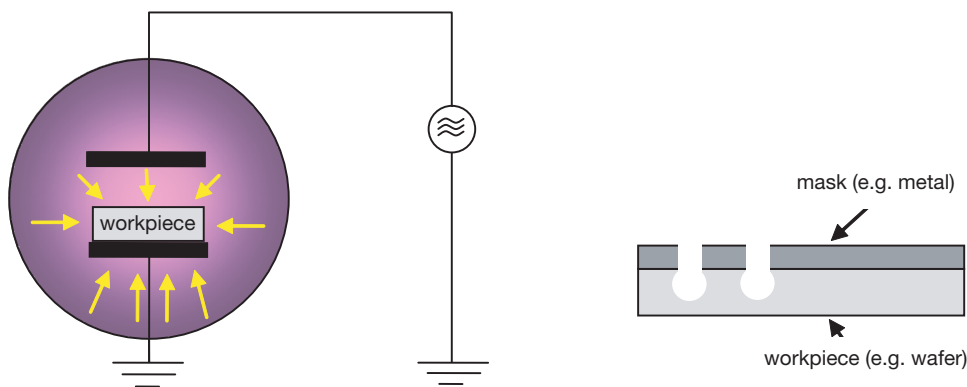

fig. 149: PE operation

The etching process is isotropic, this means plasma strikes from all directions onto the work piece. Etching is non-directional.

2.7.14.2. RIE operation

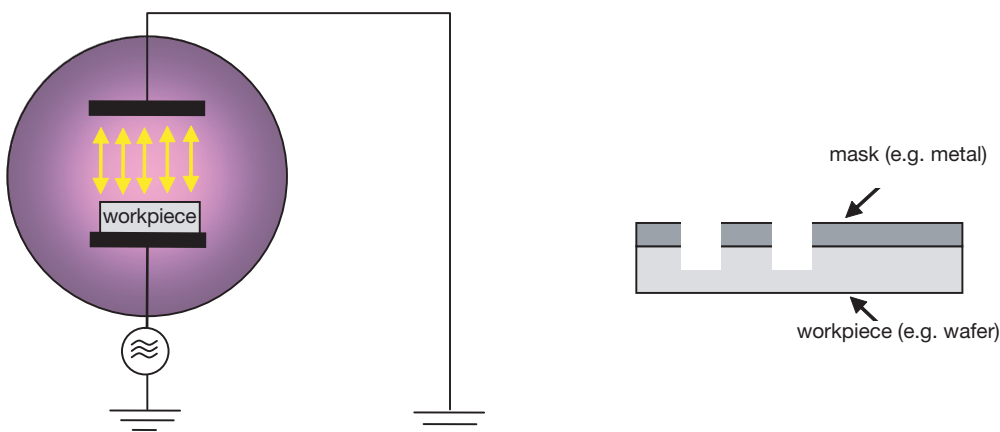

fig. 150: RIE operation

The etching process is anisotropic; this means the directed plasma hits the work piece almost vertically. This method is used in semiconductor technology / microsystem technology; i.e. structure creation of silicon wafers.



fig. 151: view to a plasma chamber
with a basic RIE electrode



fig. 152: plasma system „TETRA-30-RF“ with
RIE electrode and dark room shielding

Following is applicable to both operations:

To receive consistent results in etching temperature of the system can be optionally controlled. An increase in temperature of merely 10° C could double etching rate.

2.7.15. Ion flow measuring sensor

This is measuring flow from an electrode to mass. It hence serves process control.

2.7.16. Test inks

In our company **Fischer test inks** are used to measure surface energy. By means of test inks wetting (surface energy) on a substrate can be tested prior to plasma treatment and after. A brush integrated into the lid is used to apply liquid onto the substrate. If ink is retracting wetting of the substrate is lower than that of the test ink. If original ink brush remains, surface energy of substrate is equal or greater than that of the ink.

Special care must be taken with test inks due to their toxic substances.

Test inks can be ordered from www.fischertesttinten.de

Test kits with following inks are recommended: 28 mN/m, 34 mN/m, 41 mN/m, 44 mN/m, 48 mN/m, 56 mN/m, 72 mN/m and 105 mN/m.

It is also possible to order other values of test inks (18, 31, 64 mN/m..).



fig. 153: test inks

2.7.17. Butterfly valve

For treatment of semiconductors and maybe plasma polymerization the application of a butterfly valve is of interest. This can reduce suction. At constant pressure mass flow is constant. However, this component is quite expensive.



fig. 154: Butterfly valve

2.7.18. Active carbon filter

All production devices, which work with CF_4 , C_2F_6 , SF_6 , require active carbon filters. The pump associated must be of the dry running type otherwise oil is contaminating the filter

(see chapter I, 6.2., “Dry running vacuum pumps”). The active carbon filter is filled with basic activated carbon and neutralised; e.g. HF acid.



fig. 155: active carbon filter

2.7.19. Label Printer

Within the scope of process documentation it is possible to print customer related data to a standard printer. Important data could be, e.g. date of treatment, batch number and maximum storage time.

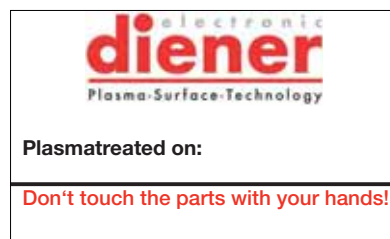

fig. 156: label

2.7.20. Suction filter for vacuum

Suction filters are important for all processes in a rotary drum.



fig. 157: suction filter



fig. 158: suction filter (interior view)

2.7.21. Barcode Reader

Should you wish to have treated parts coded or documented for security reasons, there is the opportunity to connect a barcode reader.

2.7.22. Temperature measurement with thermocouples

We usually use thermocouples to measure process control. Processes are therefore reproducible as etching rate is heavily depending on temperature.



fig. 159: thermocouples

2.7.23. Quartz glass chamber

Ordinary chambers of stainless steel can sputter to a small extent (vapourise metal). Quartz glass can only sputter SiO_2 . Borosilicate glass can sputter SiO_2 , Na_2O , K_2O , Al_2O_3 and B_2O_3 .

Glass chambers find interest in analysis technology, semiconductors and other highly sensitive parts to be treated.



fig. 160: glas chamber

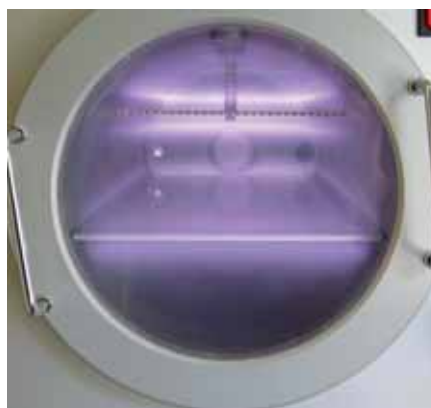

fig. 161: stainless steel chamber

2.7.24. Quartz glass boat

A “quartz glass boat” serves as a carrier of silicon wafer. This particular supporting carrier is enabling a multi-directional treatment of the wafer.

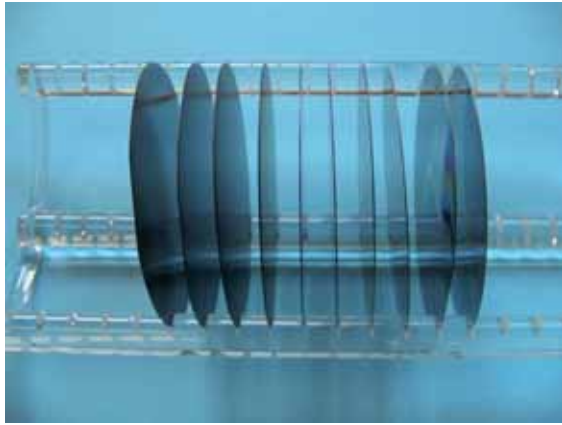

fig. 162: quartz glass boat with wafer



fig. 163: quartz glass boat

2.7.25. Generators of LF, RF, MW

We use standard generators with following frequencies:

LF	Low frequency	40 kHz	100 W; 200 W; 300 W; 1000 W; 1500 W; 2500 W
RF	Radio frequency	13.56 MHz	100 W; 300 W; 600 W; 1000 W; ...
MW	Microwave	2.45 GHz	300 W; 850 W; 1.2 kW; ...

2.7.26. Accessories for operation of special gases

Gas warning sensors are recommended for the following process gases:

- H₂
- C₂H₂
- CO
- NH₃

Gas warning sensors are able to report already small concentrations and prevent explosions or intoxications.

3. Process technology at atmospheric pressure in plasma

3.1. Applications

Atmospheric plasma technology is resulting into an increase of quality in production by surface area activation and/or cleaning.

Following applications can be carried out by the atmospheric plasma system “Plasma Beam”:

1. Precision cleaning and activation by reactive particles contained in the activated gas beam. (Radicals, see chapter 2.1.1., 2.1.2.)
2. In addition loose attached particles on the surface area are removed by the accelerated activated gas beam driven by air-compression.

The plasma beam is suited for following processes as a pre-treatment system:

- Gluing
- Bonding
- Printing
- Laminating
- Soldering
- Welding

Following surfaces can be treated:

- Plastic
- Metal
- Glass
- Ceramics
- Hybrid material



fig. 164: two plasmabeams in operation

The active gas beam coming from the plasma jet is always free from voltage potential. Voltage is so minimal, it is hardly measurable. Therefore the device can be used for different processes in the electronic industry, e.g.:

- Bond pads cleaning prior to wire bonding
- Cleaning and activation of LCD contacts prior to heat seal bonding
- Activation of microchip surfaces prior to printing
- Activation of housings in which electronic components are fitted
- Plasma treatment of electric, voltage sensitive component groups prior to casting



fig. 165: difference: plastics with and without plasma treatment

The following points are important to achieve a good surface treatment by plasma beam:

1. Treatment should always take place in motion.
2. Speed (v) of treatment and distance between plasma jet and surface (d) to be treated are the most important parameters for achieving a desired surface property. Changing parameters can have a drastic effect on pre-treatment.

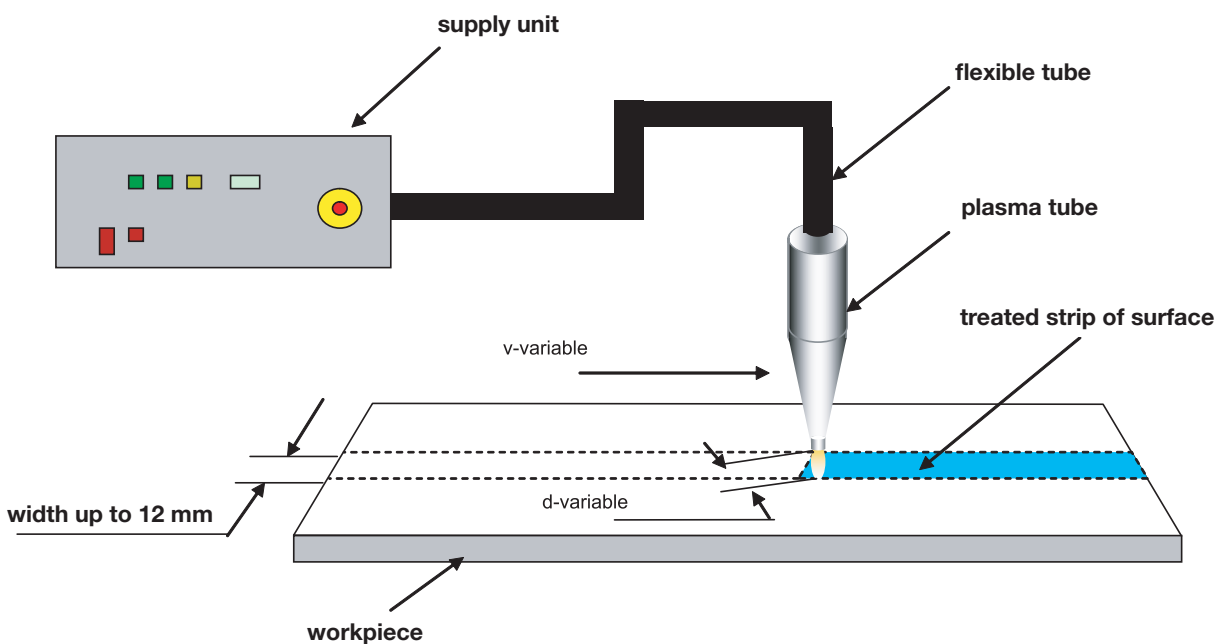

fig. 166: method of function

3.2. Principle of construction and function

The plasma system consists of three units:

Supply unit

- Electrical mains connection
- Process- and cooling gas connection
- High voltage generator
- Plasma current control block
- Gas control block
- Front panel with operation controls

Gas and power conductors in a flexible tube

Plasma Torch

The central electrode, outer electrode and insulator form a discharge zone.

- The high voltage generator creates a voltage of up to 10kV, which is necessary for the formation of the electrical discharge.
- A flexible conductor feeds supplied voltage and process gas.
- Airflow is carrying activated particles (ions, electrons, excited gas atoms and gas molecules) produced in the electrical arc away from the discharge zone.
- Flow of active gas is focused onto the part to be treated by the special plasma orifice.

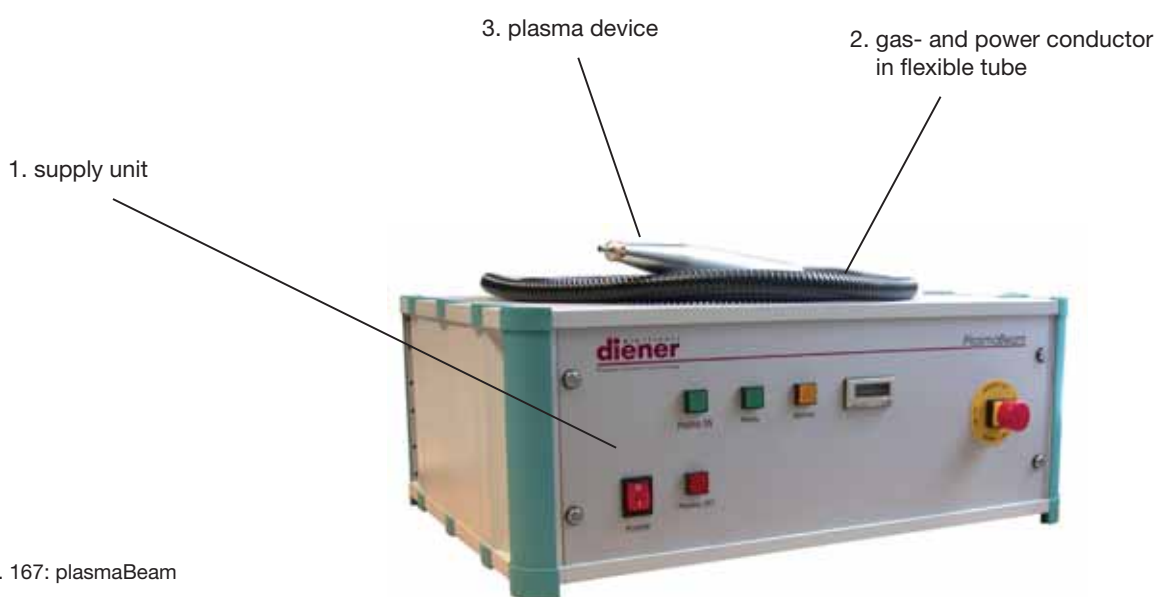

fig. 167: plasmaBeam

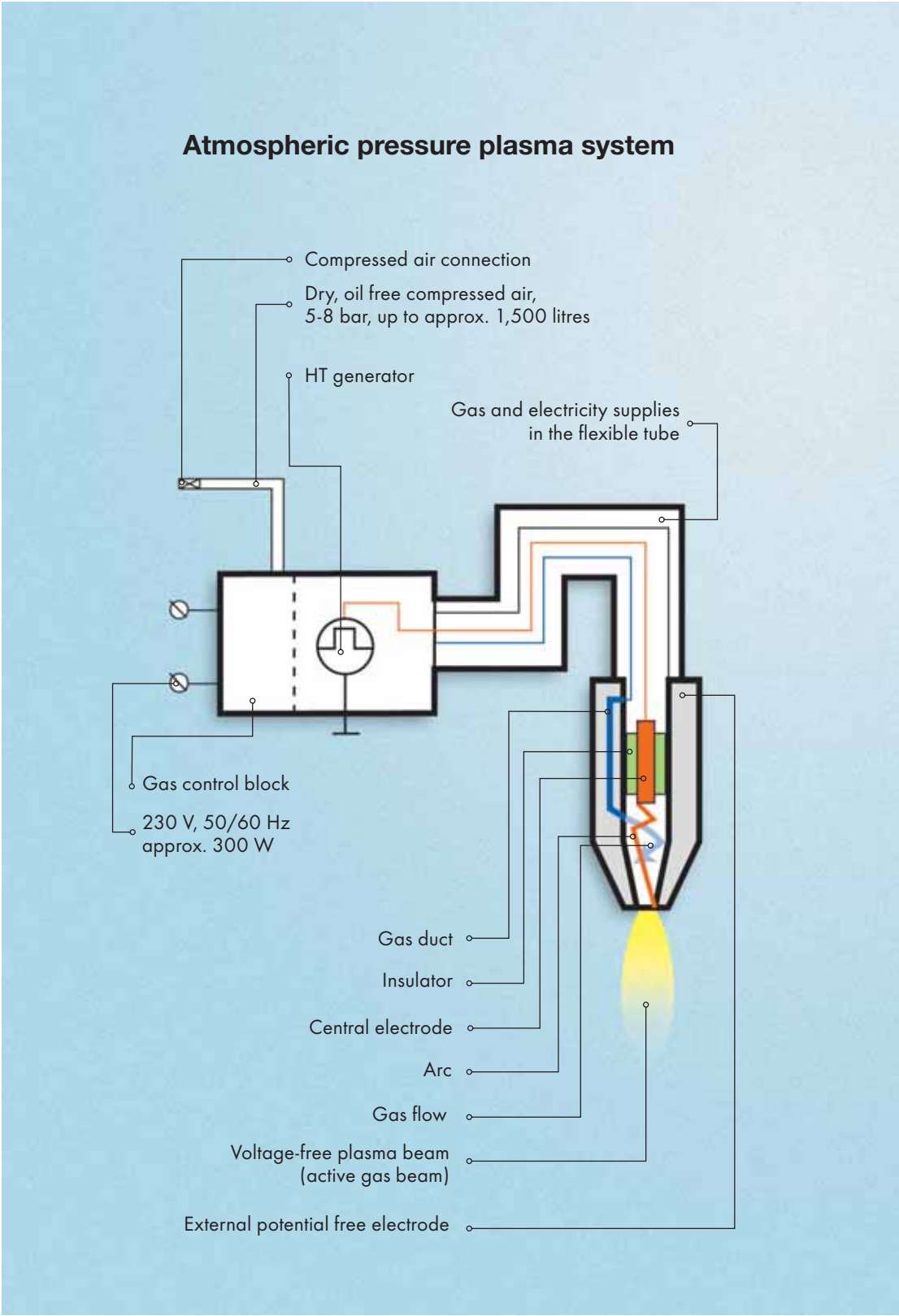

fig. 168: functional principle of a atmospheric plasma system



fig. 169: plasma stream

Control and process safety

Plasma flow and gas pressure are measured internally. In case of deviations in flow- and/or gas pressure, plasma is switching itself off. Error signals can optionally be transferred to the SUB-D connection (e.g. at SPS control) in semiautomatic operation mode.

3.3. Partial description of an atmospheric plasma system

3.3.1. Front view

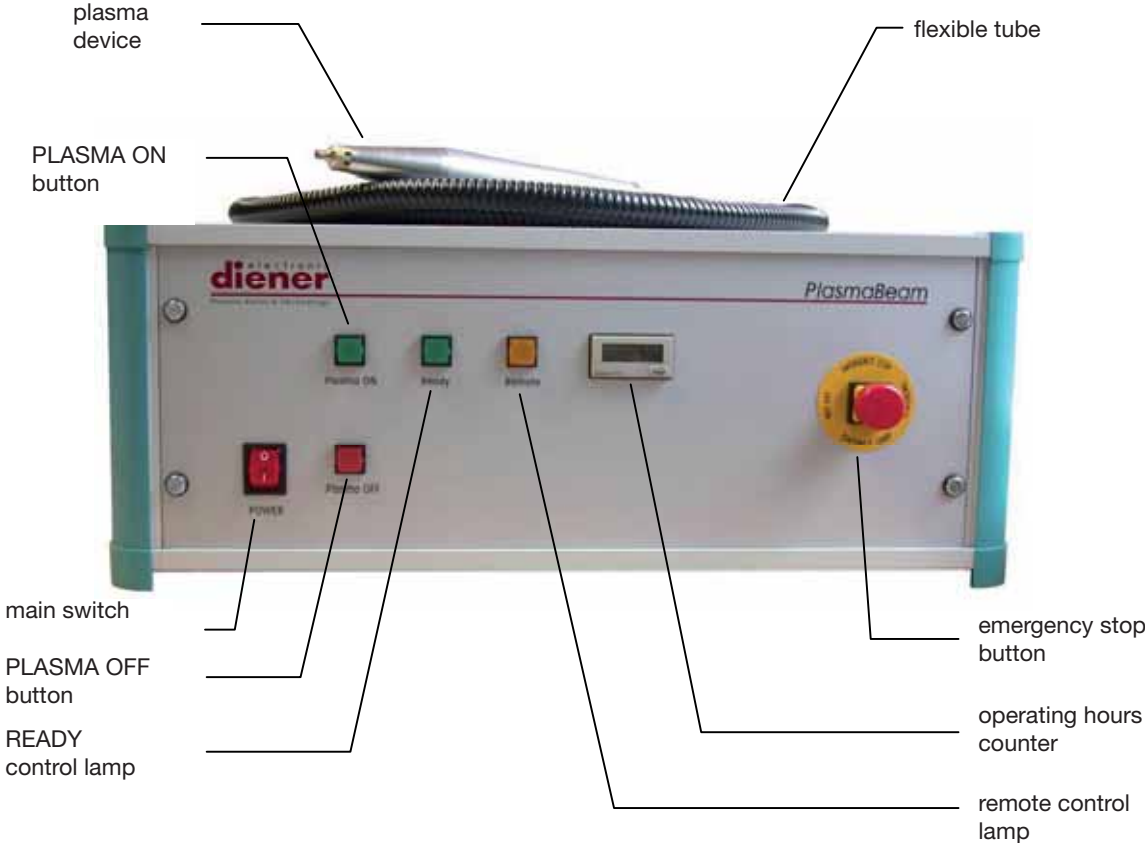

fig. 170: identification of parts (front)

3.3.2. Rear view:

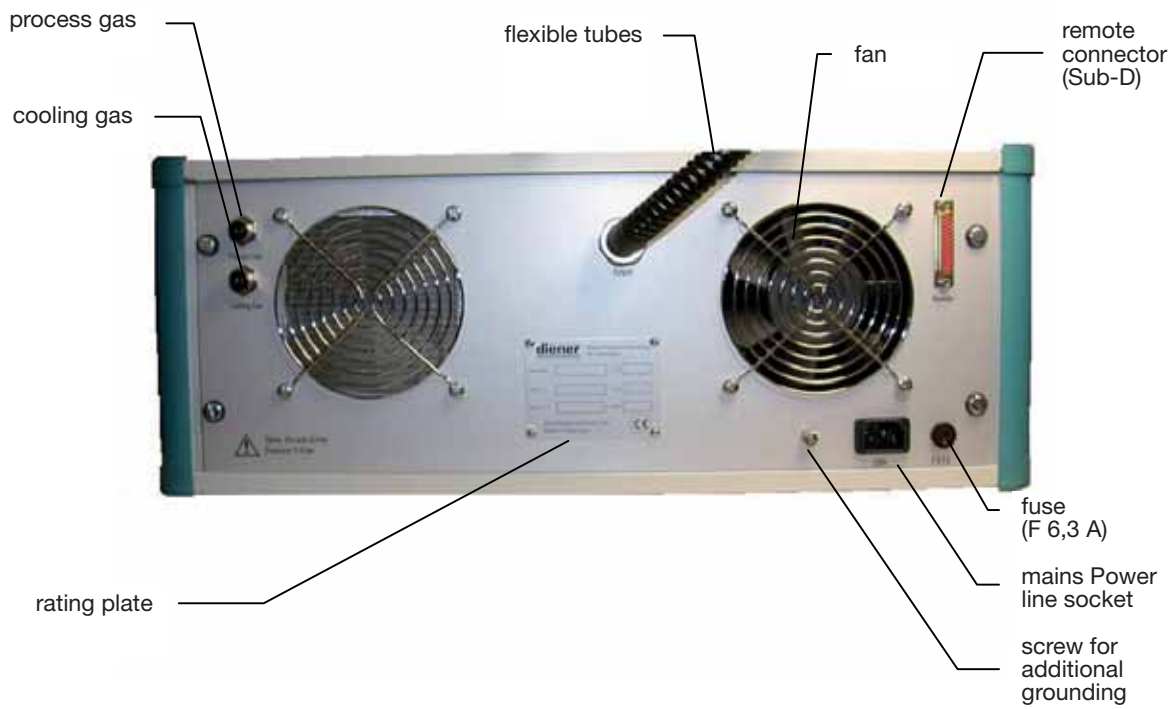

fig. 171: identification of parts (back)

3.3. Plasma Torch

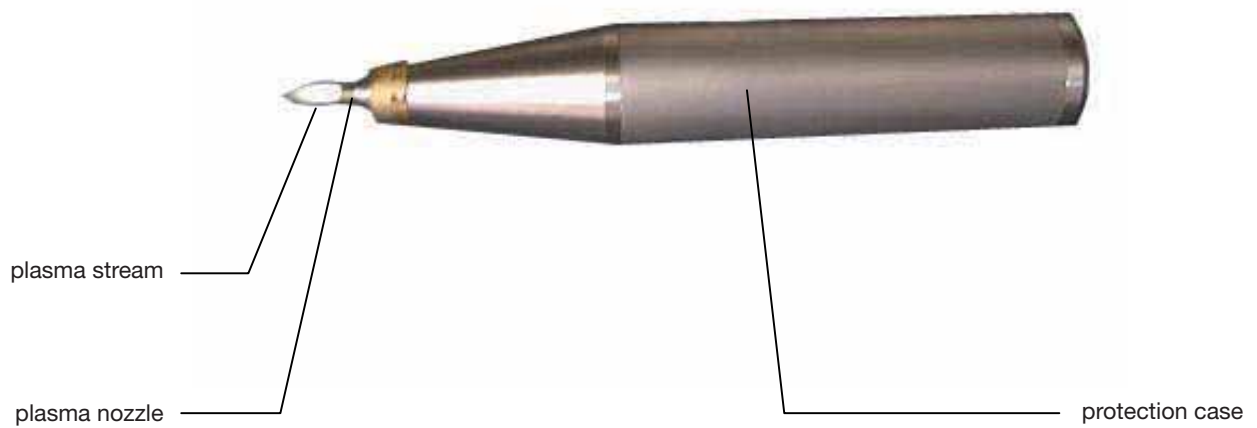

fig. 172: plasma device

3.4. Process Gas

Compressed air is usually used as a standard gas. Humid and oily compressed air can strongly influence process results and life expectancy of equipment.

Other gases, e.g. O₂ or N₂ can be used on agreement with Diener electronic. A forming gas can be used to reduce oxides, e.g. N₂H₂ compounds. No fluorine gases must be allowed or used!

3.5. Emissions

Nitrogen oxides (NO₂) are formed during the use of plasma beam with compressed air. For health reasons the system must be operated with sufficient suction (suction power 200 m³/h). Moreover metal surrounding the plasma beam is prevented from corroding.

3.6. Technical data of a standard system

1.	Measurements Supply unit	L: B: D:	562 mm 211 mm 420 mm
2.	Weight Supply unit	approx. 20 kg	
3.	Connections	Process gas: Kühlgas: Voltage supply: PE (protective earth) wire:	Quick-fit Schott connection, 6 mm Quick-fit Schott connection, 6 mm 230 V / 6 A / 50-60 Hz min. 1,5 mm ²
4.	Plasma torch	Diameter: Length: Weight: Breadth of treatment:	max. 32 mm 210 mm approx. 0.5 kg max. 12 mm
5.	Flexible tube	PVC-protected tube Bending radius ± 10 %: Length: Diameter:	60 mm 3 m 19 mm
6.	Generator	Type: Power:	switching power supply approx. 300 W

Technical modifications are subject to change



electronic
diener
Plasma-Surface-Technology

Diener electronic GmbH + Co. KG
Talstr. 5
D-72202 Nagold
Germany

Phone: +49 (0) 74 52 / 888 07-0
Fax: +49 (0) 74 52 / 888 07-50
E-Mail: info@diener-electronic.de
Internet: www.plasma.de

